

boehlerit

Gewindebearbeitung
Thread machining

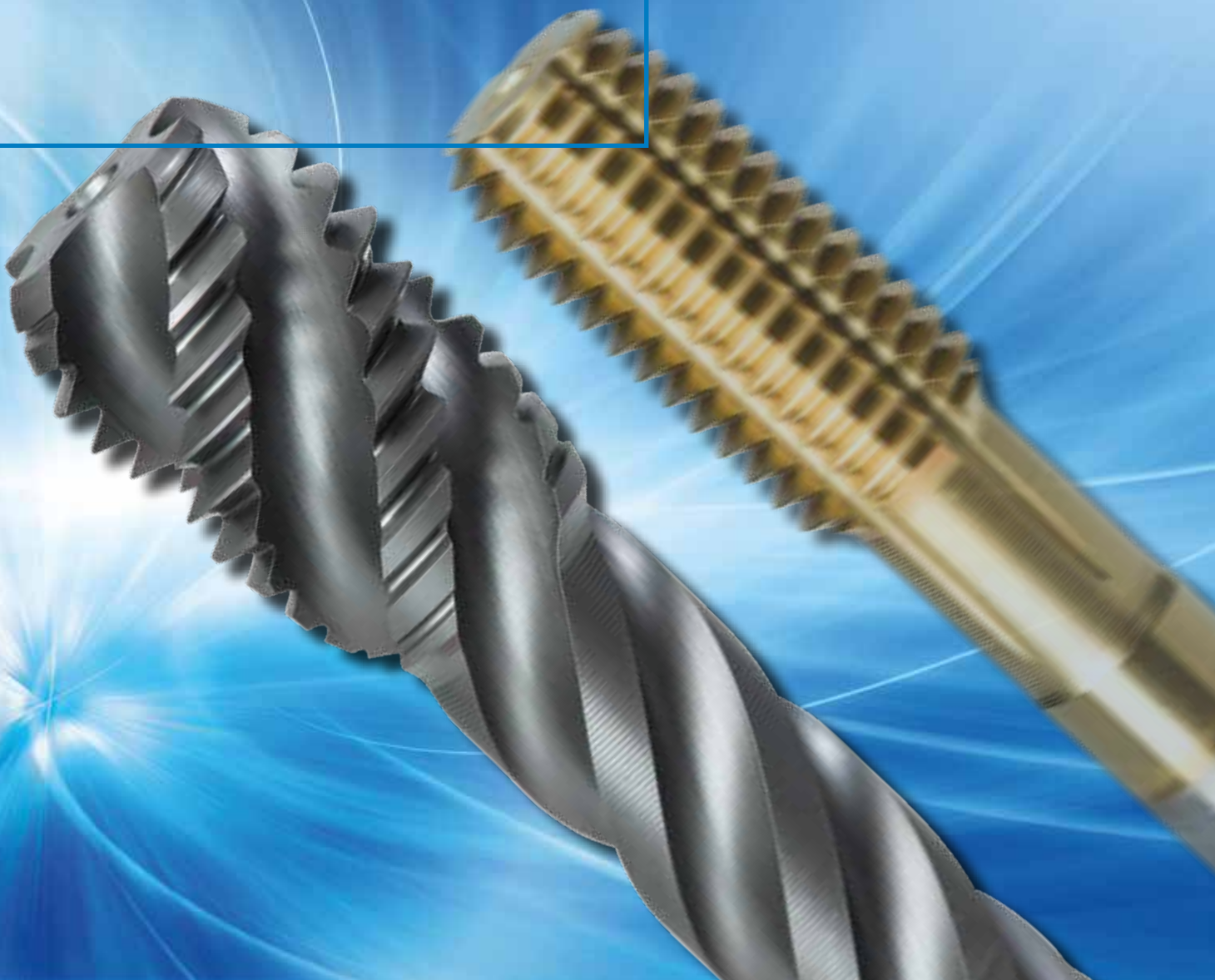

Die Marke Boehlerit wurde 1932 für die Hartmetallfertigung der Firma Böhler in Düsseldorf gegründet. 1950 begann der Aufbau der Hartmetallfertigung in der österreichischen Stahlstadt Kapfenberg, wo sich heute der Hauptstandort der Boehlerit Gruppe befindet. Ein wesentlicher Meilenstein in der Boehlerit Geschichte war die 100%ige Übernahme der gesamten Boehlerit Gruppe durch den Leitz Firmenverband aus Oberkochen / Deutschland im Jahr 1991.

Seitdem hat sich Boehlerit erfolgreich zum Schneidstoffzentrum der Leitz Firmengruppe entwickelt und zählt zu den weltweit führenden Herstellern von Schneidstoffen aus Hartmetall für Werkzeuge zur Holz-, Kunststoff- und Metallbearbeitung sowie von Werkzeugen zum Drehen, Fräsen, Bohren, Drehschälen, Hüttentechnik und der Kurbelwellenbearbeitung.

Eine weitere Stärke von Boehlerit sind Hartmetalle für Konstruktionsteile und für den Verschleißschutz.

Synergien zum Schwesterunternehmen Bilz, dem weltweit führenden Hersteller von Gewindegewindeschneidfuttern, werden zum Vorteil der weltweiten Kunden genutzt.

Produktionsstandorte

Die Boehlerit Gruppe setzt internationale Qualitätsstandards.

In modernsten Produktionsstätten wird jährlich in neue Produktionstechnologien und Kapazitätserweiterungen investiert – in Österreich, Deutschland, Spanien und der Türkei werden die Erkenntnisse aus Forschung und Entwicklung in Qualitätsprodukte umgesetzt.

Vertrieb

Die Boehlerit Gruppe, gemeinsam mit der Bilz Gruppe und exklusiven Vertriebspartnern, ist auf fast allen Kontinenten heimisch. Absolute Kundenorientierung mit schnellem Beratungs- und Lieferservice bei bester Produktqualität, so lautet unser Credo. Verantwortlich dafür sind die jeweiligen hoch spezialisierten Vertriebsgesellschaften mit über 300 geschulten Anwendungsberatern bzw. Vertriebsingenieuren. Erfahrene Außendienstmitarbeiter befinden sich weltweit stets in Rufweite der Kunden und stehen bei Kundenproblemen rasch für Beratung und Service zur Verfügung.

Forschung und Entwicklung

Durch modernste Analysemethoden und in enger Zusammenarbeit mit Universitäten und Forschungseinrichtungen begegnet die Forschungs- und Entwicklungsabteilung von Boehlerit den sich ständig verändernden Anforderungen (Produktivitätssteigerung, verbesserte Werkstoffe, neue Anwendungsbereiche) an den Schneid- und Verschleißschutzstoff Hartmetall.

Das Resultat dieser intensiven Entwicklungsarbeiten sind neue, hochqualitative und anwendungsorientierte Produkte, Made by Boehlerit.

Boehlerit – Pioneers in Carbide Development

The Boehlerit brand was established in 1932 for the carbide production of the Böhler company in Düsseldorf. 1950 was the beginning of carbide production in the Austrian steel town of Kapfenberg where the Boehlerit Group's headquarters are located today. The take-over of the entire Boehlerit Group by the Leitz Group from Oberkochen, Germany in 1991 marked an important milestone in the history of Boehlerit. Since its integration into the Leitz Group, Boehlerit has successfully developed into the group's centre for cutting materials.

It is one of the world's leading producers of carbide cutting materials for tools for wood, plastic and metal cutting and tools for turning, milling, drilling, bar peeling, steel industry and crankshaft machining.

Carbide for structural parts and wear protection are yet another core competency of Boehlerit.

Synergies with the affiliated company Bilz, the internationally leading producer of tapping chucks, are utilised to the benefit of customers worldwide.

Production sites

The Boehlerit Group sets international quality standards. Every year the company invests in new production technologies and in the expansion of capacities at its advanced production sites. High-quality products made in Austria, Germany, Spain and Turkey incorporate the latest research and development findings.

Distribution

Together with the Bilz Group and exclusive partners, Boehlerit Group is represented on nearly all continents. Absolute dedication to its customers, swift consulting and supply service and the highest product quality are its core principles. Our highly specialised distribution organisations with more than 300 qualified application consultants and sales engineers live by these principles, and our experienced field staff is always and everywhere on hand nearby to provide consultation and service for any challenge our customers may be faced with.

Research and Development

The Research and Development department of Boehlerit meets the continuously changing demands (increased productivity, improved materials, new applications) that carbide, as a cutting and wear protection material must fulfil.

It does so with its advanced analytical methods and in close cooperation with universities and research institutions. The result of the company's concentration on development are new application-oriented products of the highest quality – made by Boehlerit.

Programmübersicht Gewindebohrer	Programmübersicht Thread cutting	4
Technologievorteile	Technological advantages	6
Kundennutzen	Customer benefits	6
Bezeichnungssystem	Designation System	7
Produktlinien	Product line	
A-Linie	A-Line	
Universal Maschinengewindebohrer	Universal Machine Tap	9
P-Linie	P-Line	
Hochleistungs-Maschinengewindebohrer	Performance Tap	27
C-Linie	C-Line	
Maschinengewindeformer	Cold Forming Tap	37
S-Linie	S-Line	
Schneideisen	Round Die	45
Spannsysteme	Clamping System	57
STA Synchroneinsatz Deutsch		67
STA Synchro Tapping adapter English		71
Technische Hinweise	Technical hints	
Erklärung Anschnittformen	Explanation of the Chip Flow	76
Spanverlauf	Chamfer Forms	77
Werkstoff-Vergleichstabelle	Material-Comparison Chart	78
Härtevergleichstabelle	Conversion Table Hardness	84
Werkstofftabelle	Materials table	86
Vertriebsgesellschaften	Sales organisations	88



Kapfenberg in der Steiermark / **ÖSTERREICH** in Styria / **AUSTRIA**

Nachdruck, auch auszugsweise, ist nur mit unserer Zustimmung gestattet. Alle Rechte vorbehalten. Irrtümer, Satz- oder Druckfehler berechtigen nicht zu irgendwelchen Ansprüchen. Abbildungen, Ausführungen und Maße entsprechen dem neuesten Stand bei Herausgabe dieses Kataloges. Technische Änderungen müssen vorbehalten sein. Die bildliche Darstellung der Produkte muss nicht in jedem Falle und in allen Einzelheiten dem tatsächlichen Aussehen entsprechen.

This publication may not be reprinted in whole or part without our express permission. All right reserved. No rights may be derived from any errors in content or from typographical or typesetting errors. Diagrams, features and dimensions represent the current status on the date of issue of this catalogue. We reserve the right to make technical changes. The visual appearance of the products may not necessarily correspond to the actual appearance in all cases or in every detail.

A-Line

Universal Maschinengewindebohrer Universal Tap

HSSE

Durchgangsloch Through-hole

BA05: Metrisch metric
XL, LH, RH
BA07: Metrisch fein metric fine
BA08: G (BSP)
BA09: UNC
BA10: UNF

Seite Page 12 -18



Grundloch Blind-hole

BA60: Metrisch metric
XL, LH, RH
BA61: Metrisch fein metric fine
BA49: G (BSP)
BA50: UNC
BA51: UNF

Seite Page 19 - 25



P-Line

Hochleistungs-Maschinengewindebohrer Performance Tap

HSSE
PM

Durchgangsloch Through-hole

BP05: M mit und ohne
Kühlmittelzufuhr (RC)
M with and without coolant
supply (RC)
BP07: Mf
BP08: G (BSP)

Seite Page 29 - 32



Grundloch Blind-hole

BP60: M mit und ohne
Kühlmittelzufuhr (CC)
M with and without coolant
supply (CC)
BP61: Mf
BP49: G (BSP)

Seite Page 33 - 36



C-Line

Gewindeformer
Cold forming tap

HSSE

HSSE
PM

Durchgangsloch Through-hole
Sackloch Blind-hole

BC70 02: Metrisch metric Universal

BC70 05: Metrisch metric Performance
mit und ohne Kühlung
with and without coolant supply

Seite Page 39 - 43



S-Line

Schneideisen
Round die

HSS

HSSE

S190: Metrisch metric
LH, RH

S191: Metrisch fein metric fine

S193: G (BSP)

S194: UNC

S195: UNF

Seite Page 47 - 55



Technologievorteile
Technological advantages

Kundennutzen
Customer benefits

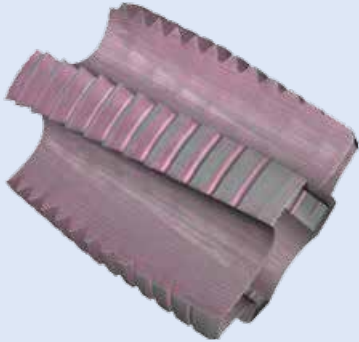
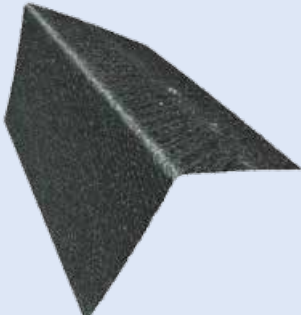
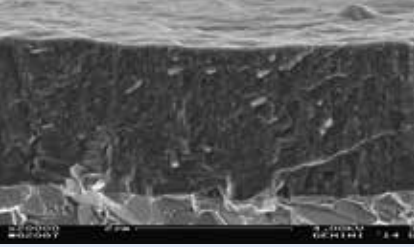
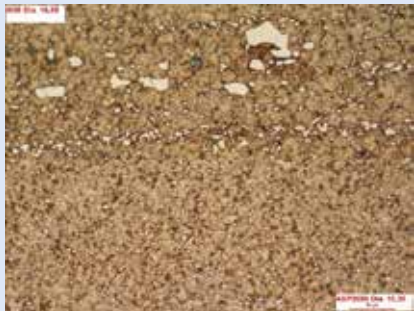
<p>Ausgewogene Geometrie mit dem Ziel Spitzenleistung in einem sehr breiten Materialspektrum.</p> <p>Well-balanced geometrical design for high performance over a huge range of materials</p>		<p>Ausgewogene Werkzeuge mit sehr breitem Anwendungsspektrum;</p> <p>Efficient tap machining on brittle as well as on tough materials</p>
<p>Besonderes Augenmerk im Bereich der Schneidkantenoptimierung</p> <p>Special focus on edge preparation</p>		<p>Einsparungspotenzial durch geringe Typenvielfalt;</p> <p>Cost-saving potential because of universal cutting materials of the tools</p>
<p>Aufwändige Vorbehandlung</p> <p>Beschichtung mit modernsten Anlagen im eigenen Haus</p> <p>Ausgefeiltes nachbehandeln (und polieren)</p> <p>Konstanter Prozess im Bereich Forschung und Weiterentwicklung</p> <p>Selective pre-treatment</p> <p>In-house coating with modern coating technology</p> <p>Special post-treatment (polishing)</p> <p>Constant research & development within product life cycle management</p>		<p>Hohe Standzeit</p> <p>Optimale Spanabfuhr</p> <p>Höhere Schnittgeschwindigkeiten</p> <p>Breiteres Anwendungsspektrum</p> <p>High tool life</p> <p>Optimum chip removal</p> <p>Higher cutting speed</p> <p>Wide range of applications</p>
<p>Auf das jeweilige Werkzeug und den Anwendungsbereich abgestimmtes Grundmaterial</p> <p>Selected and special characteristics offering cutting materials for each tool and application</p>		<p>Standzeit und Qualität der Gewinde auf hohem Niveau</p> <p>Tool life and quality of threads on high end level</p>

Technologievorteile
Technological advantages

Kundennutzen
Customer benefits

<p>Aufwendige über lange Jahre hinweg optimierte Wärmebehandlung</p> <p>Elaborate and over years optimized heat treatment process</p>		<p>Geringerer Verschleiß und verbesserte Standzeit</p> <p>Optimized tool life through higher wear resistance</p>
---	---	--

Bezeichnungssystem
Designation / Nomination

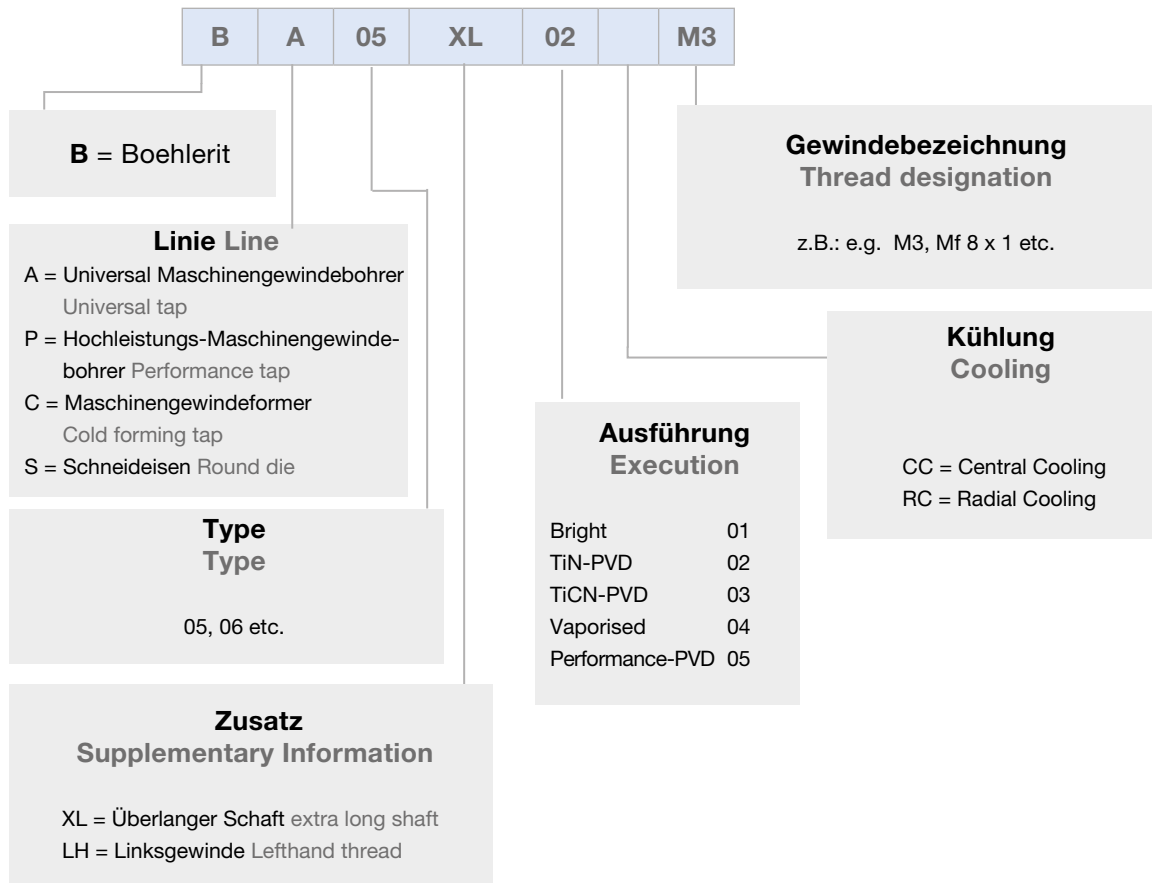

Katalog Symbole
Catalogue symbols

Material
Material

HSS	Hochleistungsschnellstahl Conventional high speed steel
HSSE	Hochleistungsschnellstahl besonders verschleißbeständig Conventional high speed steel, more wear resistant
HSSE PM	Hochleistungsschnellstahl Pulvermetallurgisch Conventional high speed steel, powder metallurgy

Beschichtung
Coating

TiN B+	TiN-PVD Beschichtung TiN-PVD coating
TiCN B+	TiCN-PVD Beschichtung TiCN-PVD coating
VAP	Vaporisierte Oberfläche vaporised surface
B-XT	B-XT Hochleistungs PVD-Beschichtung B-XT performance PVD coating

Kernloch
Core diameter

	Durchgangsloch Through hole
	Grundloch Blind hole
	Durchgangsloch und Grundloch Through and blind hole

Gewindeart
Thread type

M	ISO Metrisches Gewinde - DIN 13 ISO metric coarse thread - DIN 13
Mf	ISO Metrisches Fein Gewinde - DIN 13 ISO metric fine coarse thread - DIN 13
G (BSP)	Britisch Standard Rohrgewinde - EN ISO 228 British standard pipe thread - EN ISO 228
UNC	Unified coarse thread - UNC ASME B1.1 Unified coarse thread - UNC ASME B1.1
UNF	Unified fine thread - UNF ASME B1.1 Unified fine thread - UNF ASME B1.1

Schnittrichtung
Cutting direction

RH	Rechtsgewinde Righthand
LH	Linksgewinde Lefthand

max. Gewindetiefe max. Depth of thread	2xD	2.5xD	3xD
--	------------	--------------	------------





Anschnittform Thread type	B	C
-------------------------------------	----------	----------

(genaue Beschreibung S. 76, exact description page 76)

Drallwinkel Helix angle	40° RSP	45° RSP
-----------------------------------	----------------	----------------

A-Line
Universal
Maschinengewindebohrer
Universal Machine tap



Maschinengewindebohrer für Durchgangsloch Taps for through holes							
	BA05 Metrisch metric	BA05 XL Metrisch XL metric XL	BA05 LH Metrisch LH metric LH	BA07 Metrisch fein metric fine	BA08 G (BSP) G (BSP)	BA09 UNC UNC	BA10 UNF UNF
							
Seite/Page	12	13	14	15	16	17	18
P.1	30-35	30-35	30-35	30-35	30-35	30-35	30-35
P.2	30-35	25-30	30-35	30-35	30-35	30-35	30-35
P.3	25-30	20-25	25-30	25-30	25-30	25-30	25-30
P.4	20-25	15-20	20-25	20-25	20-25	20-25	20-25
P.5	10-15		10-15	10-15	10-15	10-15	10-15
P.6							
P.7	10-15	6-8	10-15	10-15	10-15	10-15	10-15
M.1	10-15	6-8	10-15	10-15	10-15	10-15	10-15
M.2	6-8	3-5	6-8	6-8	6-8	6-8	6-8
K.1							
K.2	25-30	20-25	25-30	25-30	25-30	25-30	25-30
K.3							
N.1	30-35	30-35	30-35	30-35	30-35	30-35	30-35
N.2	30-35	25-30	30-35	30-35	30-35	30-35	30-35
N.3	30-35	25-30	30-35	30-35	30-35	30-35	30-35
N.4							
N.5	25-30	25-30	25-30	25-30	25-30	25-30	25-30
N.6	25-30	20-25	25-30	25-30	25-30	25-30	25-30
N.7							
N.8							
N.9							
N.10							
S.1							
S.2							
S.3	12-15		12-15	12-15	12-15	12-15	12-15
S.4							
H.1							
H.2							

Werkstoffgruppenerklärung ab Seite 78, description of material group see page 78)
 A / P / C / S - Line

Maschinengewindebohrer für Grundloch
Taps for blind holes

	BA60 Metrisch metric	BA60 XL Metrisch XL metric XL	BA60 LH Metrisch LH metric LH	BA61 Metrisch fein metric fine	BA49 G (BSP) G (BSP)	BA50 UNC UNC	BA51 UNF UNF
							
Seite/Page	19	20	21	22	23	24	25
P.1	15-18	25-30	15-18	15-18	15-18	15-18	15-18
P.2	25-30	20-25	25-30	25-30	25-30	25-30	25-30
P.3	20-25	15-20	20-25	20-25	20-25	20-25	20-25
P.4	15-20		15-20	15-20	15-20	15-20	15-20
P.5	5-10		5-10	5-10	5-10	5-10	5-10
P.6							
P.7	8-10		8-10	8-10	8-10	8-10	8-10
M.1	8-10		8-10	8-10	8-10	8-10	8-10
M.2	3-5		3-5	3-5	3-5	3-5	3-5
K.1							
K.2	20-25	15-20	20-25	20-25	20-25	20-25	20-25
K.3							
N.1		25-30					
N.2	30-35	25-30	30-35	30-35	30-35	30-35	30-35
N.3	25-30	20-25	25-30	25-30	25-30	25-30	25-30
N.4							
N.5		20-25					
N.6	25-30	20-25	25-30	25-30	25-30	25-30	25-30
N.7							
N.8							
N.9							
N.10							
S.1							
S.2							
S.3	8-10		8-10	8-10	8-10	8-10	8-10
S.4							
H.1							
H.2							

Werkstoffgruppenerklärung ab Seite 78, description of material group see page 78)
A / P / C / S - Line

Maschinengewindebohrer Durchgangsloch - Metrisch Rechts
Machine tap through-hole - metric right

BA05

A-Line



BA05 02		
ISO		[m/min]
P	P.2	30-35
	P.3	25-30
	P.4	20-25
	P.5	10-15
	P.7	10-15
M	M.1	10-15
K	K.2	25-30
N	N.2	30-35
	N.3	30-35
	N.6	25-30



DIN 371 (M2 - M10)

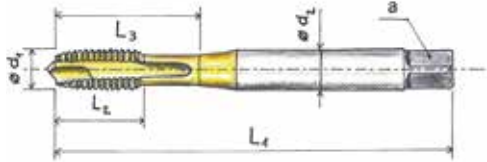

DIN 371

DIN 376 (M12 - M30)

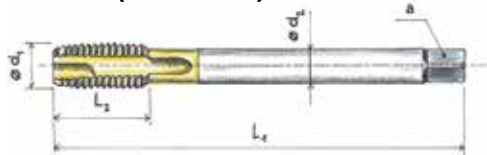

DIN 376

	d1 [mm]	P [mm]	L1 [mm]	L2 [mm]	L3 [mm]	d2 [mm]	a [mm]	z [-]	[mm]	Verfügbarkeit Availability	Bestellbezeichnung Ordering Code
M	2	0.4	45	7	11	2.8	2.1	2	1.6	●	BA05 02 M2
M	2.2	0.45	45	8	13	2.8	2.1	2	1.75	●	BA05 02 M2.2
M	2.5	0.45	50	9	15	2.8	2.1	3	2.05	●	BA05 02 M2.5
M	2.6	0.45	50	9	15	2.8	2.1	3	2.1	●	BA05 02 M2.6
M	3	0.5	56	10	18	3.5	2.7	3	2.5	●	BA05 02 M3
M	3.5	0.6	56	11	20	4	3	3	2.9	●	BA05 02 M3.5
M	4	0.7	63	12	21	4.5	3.4	3	3.3	●	BA05 02 M4
M	5	0.8	70	14	24.5	6	4.9	3	4.2	●	BA05 02 M5
M	6	1	80	16	29	6	4.9	3	5	●	BA05 02 M6
M	7	1	80	16	29	7	5.5	3	6	●	BA05 02 M7
M	8	1.25	90	18	33	8	6.2	3	6.8	●	BA05 02 M8
M	9	1.25	90	18	33	9	7	3	7.8	●	BA05 02 M9
M	10	1.5	100	20	36	10	8	3	8.5	●	BA05 02 M10
Mit Überlaufschaft with standard straight shank											
M	12	1.75	110	24	-	9	7	4	10.2	●	BA05 02 M12
M	14	2	110	25	-	11	9	4	12	●	BA05 02 M14
M	16	2	110	28	-	12	9	4	14	●	BA05 02 M16
M	18	2.5	125	32	-	14	11	4	15.5	●	BA05 02 M18
M	20	2.5	140	32	-	16	12	4	17.5	●	BA05 02 M20
M	22	2.5	140	32	-	18	14.5	4	19.5	●	BA05 02 M22
M	24	3	160	36	-	18	14.5	4	21	●	BA05 02 M24
M	27	3	160	36	-	20	16	4	24	●	BA05 02 M27
M	30	3.5	180	40	-	22	18	4	26.5	●	BA05 02 M30

Bestellbeispiel Order example: 1Stück Piece BA05 02 M2

- Verfügbar ab Lager Available from stock
- kurzfristig lieferbar shortly available

BA05 XL

A-Line

HSSE

TiN
B+

M  RH 2.5xD B XL

BA05XL 02		
ISO		[m/min]
P	P.1	30-35
	P.2	25-30
	P.3	20-25
N	N.2	25-30
	N.6	20-25



DIN 371 (M3 - M10)

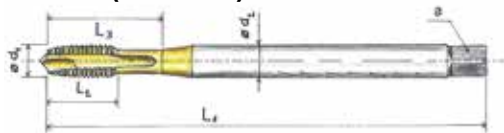

DIN
371

DIN 376 (M12 - M20)

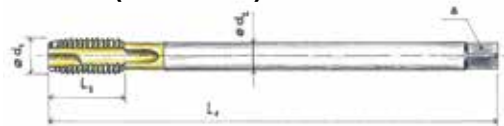

DIN
376

	d1 [mm]	P [mm]	L1 [mm]	L2 [mm]	L3 [mm]	d2 [mm]	a [mm]	z [-]	 [mm]	Verfügbarkeit Availability	Bestellbezeichnung Ordering Code
M	3	0.5	112	10	18	3.5	2.7	3	2.5	●	BA05 XL 02 M3
M	4	0.7	112	12	21	4.5	3.4	3	3.3	●	BA05 XL 02 M4
M	5	0.8	125	14	24.5	6	4.9	3	4.2	●	BA05 XL 02 M5
M	6	1	125	16	29	6	4.9	3	5	●	BA05 XL 02 M6
M	8	1.25	140	18	33	8	6.2	3	6.8	●	BA05 XL 02 M8
M	10	1.5	160	20	36	10	8	3	8.5	●	BA05 XL 02 M10
Mit Überlaufschaft with standard straight shank											
M	12	1.75	180	24	-	9	7	3	10.2	●	BA05 XL 02 M12
M	16	2	200	28	-	12	9	3	14	●	BA05 XL 02 M16
M	20	2.5	225	32	-	16	12	4	17.5	●	BA05 XL 02 M20

BA05 LH

A-Line



DIN 371 (M3 - M10)

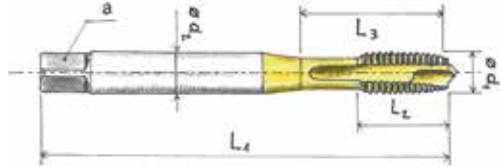

DIN 371

DIN 376 (M12 - M20)

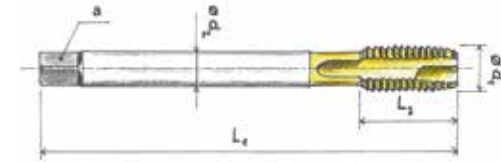

DIN 376

BA05LH02		
ISO		[m/min]
P	P.2	30-35
	P.3	25-30
	P.4	20-25
	P.5	10-15
	P.7	10-15
M	M.1	10-15
K	K.2	25-30
N	N.2	30-35
	N.3	30-35
	N.6	25-30



	d1 [mm]	P [mm]	L1 [mm]	L2 [mm]	L3 [mm]	d2 [mm]	a [mm]	z [-]	[mm]	Verfügbarkeit Availability	Bestellbezeichnung Ordering Code
M	3	0.5	56	10	18	3.5	2.7	3	2.5	●	BA05 LH 02 M3
M	4	0.7	63	12	21	4.5	3.4	3	3.3	●	BA05 LH 02 M4
M	5	0.8	70	14	24.5	6	4.9	3	4.2	●	BA05 LH 02 M5
M	6	1	80	16	29	6	4.9	3	5	●	BA05 LH 02 M6
M	8	1.25	90	18	33	8	6.2	3	6.8	●	BA05 LH 02 M8
M	10	1.5	100	20	36	10	8	3	8.5	●	BA05 LH 02 M10
Mit Überlaufschaft with standard straight shank											
M	12	1.75	110	24	-	9	7	4	10.2	●	BA05 LH 02 M12
M	16	2	110	28	-	12	9	4	14	●	BA05 LH 02 M16
M	20	2.5	140	32	-	16	12	4	17.5	●	BA05 LH 02 M20

BA07

A-Line

HSSE	TiN B+
------	-----------

Mf		RH	2.5xD	B
----	--	----	-------	---

DIN 374

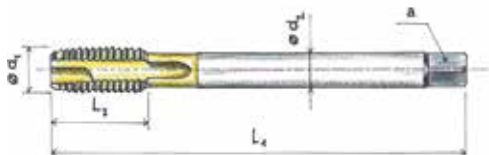

DIN 374

BA07 02		
ISO		[m/min]
P	P.2	30-35
	P.3	25-30
	P.4	20-25
	P.5	10-15
	P.7	10-15
M	M.1	10-15
K	K.2	25-30
N	N.2	30-35
	N.3	30-35
	N.6	25-30



	d1 [mm]	P [mm]	L1 [mm]	L2 [mm]	L3 [mm]	d2 [mm]	a [mm]	z [-]	[mm]	Verfügbarkeit Availability	Bestellbezeichnung Ordering Code
Mf	6	0.75	80	14	-	4.5	3.4	3	5.2	●	BA07 02 Mf 6x0.75
Mf	8	1	90	16	-	6	4.9	3	7	●	BA07 02 Mf 8x1
Mf	10	1	90	18	-	7	5.5	4	9	●	BA07 02 Mf 10x1
Mf	10	1.25	100	18	-	7	5.5	3	8.8	●	BA07 02 Mf 10x1.25
Mf	12	1.00	100	22	-	9	7	4	11	●	BA07 02 Mf 12x1
Mf	12	1.25	100	22	-	9	7	4	10.8	●	BA07 02 Mf 12x1.25
Mf	12	1.50	100	22	-	9	7	3	10.5	●	BA07 02 Mf 12x1.5
Mf	14	1.25	100	22	-	11	9	4	12.8	●	BA07 02 Mf 14x1.25
Mf	14	1.50	100	22	-	11	9	4	12.5	●	BA07 02 Mf 14x1.5
Mf	16	1.50	100	22	-	12	9	4	14.5	●	BA07 02 Mf 16x1.5
Mf	18	1.50	110	25	-	14	11	4	16.5	●	BA07 02 Mf 18x1.5
Mf	20	1.50	125	25	-	16	12	4	18.5	●	BA07 02 Mf 20x1.5
Mf	22	1.50	125	25	-	18	14.5	4	20.5	●	BA07 02 Mf 22x1.5
Mf	24	1.50	140	25	-	18	14.5	4	22.5	●	BA07 02 Mf 24x1.5
Mf	27	1.50	140	28	-	20	16	4	25.5	●	BA07 02 Mf 27x1.5
Mf	30	1.50	150	28	-	22	18	4	28.5	●	BA07 02 Mf 30x1.5

Maschinengewindebohrer Durchgangsloch - British Standard Rohrgewinde
Machine tap through-hole - British Standard Pipe Thread

BA08

A-Line

HSSE	TiN B+
------	-----------

G (BSP)		RH	2.5xD	B
------------	---	----	-------	---

DIN 5156

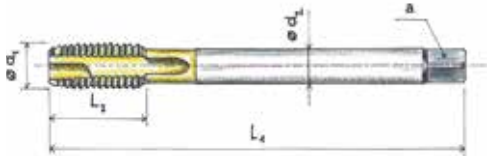

DIN
5156

BA08 02		
ISO		[m/min]
P	P.2	30-35
	P.3	25-30
	P.4	20-25
	P.5	10-15
	P.7	10-15
M	M.1	10-15
K	K.2	25-30
N	N.2	30-35
	N.3	30-35
	N.6	25-30



G	P [TP]	d1 [mm]	L1 [mm]	L2 [mm]	L3 [mm]	d2 [mm]	a [mm]	z [-]	 [mm]	Verfügbarkeit Availability	Bestellbezeichnung Ordering Code
1/8"	28	9.73	90	18	-	7	5.5	4	8.8	●	BA08 02 G 1/8"
1/4"	19	13.16	100	22	-	11	9	4	11.80	●	BA08 02 G 1/4"
3/8"	19	16.66	100	22	-	12	9	4	15.25	●	BA08 02 G 3/8"
1/2"	14	20.96	125	25	-	16	12	4	19	●	BA08 02 G 1/2"
5/8"	14	22.91	125	25	-	18	14.5	4	21	●	BA08 02 G 5/8"
3/4"	14	26.44	140	28	-	20	16	4	24.5	●	BA08 02 G 3/4"
7/8"	14	30.20	150	28	-	22	18	4	28.25	●	BA08 02 G 7/8"
1"	11	33.25	160	30	-	25	20	4	30.75	●	BA08 02 G 1"

Bestellbeispiel Order example: 1Stück Piece BA08 02 G 1/8"

- Verfügbar ab Lager Available from stock
- kurzfristig lieferbar shortly available

BA09

A-Line



DIN 371 (No.2 - 1/4)

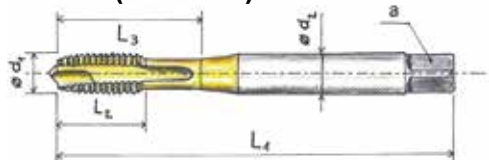

DIN 371

DIN 376 (5/16 - 1)



DIN 376

BA09 02		
ISO		[m/min]
P	P.2	30-35
	P.3	25-30
	P.4	20-25
	P.5	10-15
	P.7	10-15
M	M.1	10-15
K	K.2	25-30
N	N.2	30-35
	N.3	30-35
	N.6	25-30



UNC	P [TPI]	d1 [mm]	L1 [mm]	L2 [mm]	L3 [mm]	d2 [mm]	a [mm]	z [-]	⌀ [mm]	Verfügbarkeit Availability	Bestellbezeichnung Ordering Code
No. 2	56	2.18	45	8	13	2.8	2.1	2	1.85	●	BA09 02 UNC Nr.2
No. 3	48	2.52	50	9	15	2.8	2.1	3	2.1	●	BA09 02 UNC Nr.3
No. 4	40	2.85	56	10	18	3.5	2.7	3	2.35	●	BA09 02 UNC Nr.4
No. 5	40	3.18	56	10	18	3.5	2.7	3	2.65	●	BA09 02 UNC Nr.5
No. 6	32	3.51	56	11	20	4	3	3	2.85	●	BA09 02 UNC Nr.6
No. 8	32	4.17	63	13	22	4.5	3.4	3	3.5	●	BA09 02 UNC Nr.8
No.10	24	4.83	70	16	26.5	6	4.9	3	3.9	●	BA09 02 UNC Nr.10
No.12	24	5.49	80	16	26.5	6	4.9	3	4.5	●	BA09 02 UNC Nr.12
1/4	20	6.35	80	17	30	7	5.5	3	5.1	●	BA09 02 UNC 1/4"
Mit Überlaufschaft with standard straight shank											
5/16	18	7.94	90	18	-	6	4.9	3	6.6	●	BA09 02 UNC 5/16"
3/8	16	9.53	100	22	-	7	5.5	3	8	●	BA09 02 UNC 3/8"
7/16	14	11.11	100	24	-	8	6.2	3	9.4	●	BA09 02 UNC 7/16"
1/2	13	12.70	110	26	-	9	7	3	10.8	●	BA09 02 UNC 1/2"
9/16	12	14.29	110	28	-	11	9	3	12.2	●	BA09 02 UNC 9/16"
5/8	11	15.88	110	28	-	12	9	3	13.5	●	BA09 02 UNC 5/8"
3/4	10	19.05	125	32	-	14	11	4	16.5	●	BA09 02 UNC 3/4"
7/8	9	22.23	140	32	-	18	14.5	4	19.5	●	BA09 02 UNC 7/8"
1	8	25.40	160	36	-	18	14.5	4	22.25	●	BA09 02 UNC 1"

Bestellbeispiel Order example: 1Stück Piece BA09 02 UNC Nr.2

- Verfügbar ab Lager Available from stock
- ⦿ kurzfristig lieferbar shortly available

BA10

A-Line



DIN 371 (No. 2 - 1/4)

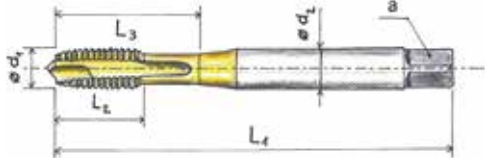

DIN 371

DIN 376 (5/16 - 1)

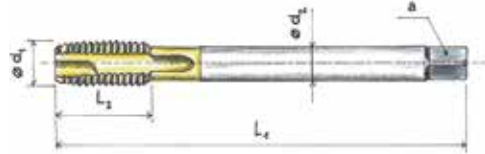

DIN 376

BA10 02		
ISO		[m/min]
P	P.2	30-35
	P.3	25-30
	P.4	20-25
	P.5	10-15
	P.7	10-15
M	M.1	10-15
K	K.2	25-30
N	N.2	30-35
	N.3	30-35
	N.6	25-30



UNF	P [TPI]	d1 [mm]	L1 [mm]	L2 [mm]	L3 [mm]	d2 [mm]	a [mm]	z [-]	φ [mm]	Verfügbarkeit Availability	Bestellbezeichnung Ordering Code
No. 2	64	2.18	45	8	13	2.8	2.1	2	1.85	●	BA10 02 UNF Nr.2
No. 3	56	2.52	50	9	15	2.8	2.1	3	2.15	●	BA10 02 UNF Nr.3
No. 4	48	2.85	56	10	18	3.5	2.7	3	2.4	●	BA10 02 UNF Nr.4
No. 5	44	3.18	56	10	18	3.5	2.7	3	2.7	●	BA10 02 UNF Nr.5
No. 6	40	3.51	56	11	20	4	3	3	2.95	●	BA10 02 UNF Nr.6
No. 8	36	4.17	63	12	21	4.5	3.4	3	3.5	●	BA10 02 UNF Nr.8
No.10	32	4.83	70	14	24.5	6	4.9	3	4.1	●	BA10 02 UNF Nr.10
No.12	28	5.49	80	16	26.5	6	4.9	3	4.6	●	BA10 02 UNF Nr.12
1/4	28	6.35	80	16	30	7	5.5	3	5.5	●	BA10 02 UNF 1/4"
Mit Überlaufschaft with standard straight shank											
5/16	24	7.94	90	18	-	6	4.9	3	6.9	●	BA10 02 UNF 5/16"
3/8	24	9.53	90	18	-	7	5.5	3	8.5	●	BA10 02 UNF 3/8"
7/16	20	11.11	100	20	-	8	6.2	3	9.9	●	BA10 02 UNF 7/16"
1/2	20	12.70	100	22	-	9	7	4	11.5	●	BA10 02 UNF 1/2"
9/16	18	14.29	100	22	-	11	9	4	12.9	●	BA10 02 UNF 9/16"
5/8	18	15.88	100	22	-	12	9	4	14.5	●	BA10 02 UNF 5/8"
3/4	16	19.05	110	25	-	14	11	4	17.5	●	BA10 02 UNF 3/4"
7/8	14	22.23	125	25	-	18	14.5	4	20.4	●	BA10 02 UNF 7/8"
1	12	25.40	140	28	-	18	14.5	4	23.25	●	BA10 02 UNF 1"

BA60

A-Line

HSSE

TiN
B+

M		RH	2.5xD	C	40° RSP
---	--	----	-------	---	---------

DIN 371 (M2 - M10)

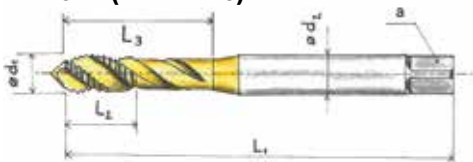

DIN 371

DIN 376 (M12 - M30)

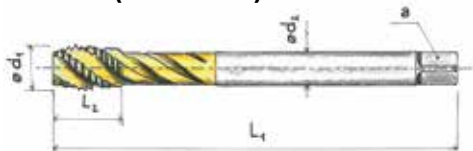

DIN 376

BA60 02		
ISO		[m/min]
P	P.3	20-25
	P.4	15-20
	P.5	5-10
	P.7	8-10
M	M.1	8-10
K	K.2	20-25
N	N.3	25-30
	N.6	25-30



	d1 [mm]	P [mm]	L1 [mm]	L2 [mm]	L3 [mm]	d2 [mm]	a [mm]	z [-]	[mm]	Verfügbarkeit Availability	Bestellbezeichnung Ordering Code
M	2	0.4	45	6	12	2.8	2.1	3	1.6	●	BA60 02 M2
M	2.5	0.45	50	6.5	15	2.8	2.1	3	2.05	●	BA60 02 M2.5
M	3	0.5	56	7	15	3.5	2.7	3	2.5	●	BA60 02 M3
M	3.5	0.6	56	8	18.5	4	3	3	2.9	●	BA60 02 M3.5
M	4	0.7	63	8.5	21	4.5	3.4	3	3.3	●	BA60 02 M4
M	5	0.8	70	10	24.5	6	4.9	3	4.2	●	BA60 02 M5
M	6	1	80	12	29	6	4.9	3	5	●	BA60 02 M6
M	7	1	80	12	29	7	5.5	3	6	●	BA60 02 M7
M	8	1.25	90	15	33	8	6.2	3	6.8	●	BA60 02 M8
M	9	1.25	90	15	33	9	7	3	7.8	●	BA60 02 M9
M	10	1.5	100	17.5	38	10	8	3	8.5	●	BA60 02 M10
Mit Überlaufschaft with standard straight shank											
M	12	1.75	110	18	-	9	7	4	10.2	●	BA60 02 M12
M	14	2	110	20.5	-	11	9	4	12	●	BA60 02 M14
M	16	2	110	20.5	-	12	9	4	14	●	BA60 02 M16
M	18	2.5	125	25.5	-	14	11	4	15.5	●	BA60 02 M18
M	20	2.5	140	29.5	-	16	12	4	17.5	●	BA60 02 M20
M	22	2.5	140	29.5	-	18	14.5	4	19.5	●	BA60 02 M22
M	24	3	160	35.5	-	18	14.5	4	21	●	BA60 02 M24
M	27	3	160	37.5	-	20	16	5	24	●	BA60 02 M27
M	30	3.5	180	42	-	22	18	5	26.5	●	BA60 02 M30

Bestellbeispiel Order example: 1Stück Piece BA60 02 M2

- Verfügbar ab Lager Available from stock
- kurzfristig lieferbar shortly available

BA60 XL

A-Line

HSSE	TiN B+
------	-----------

M		RH	2.5xD	C	40° RSP	XL
---	---	----	-------	---	------------	----

DIN 371 (M3 - M10)

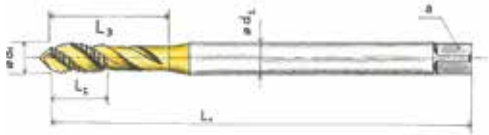

DIN
371

DIN 376 (M12 - M20)

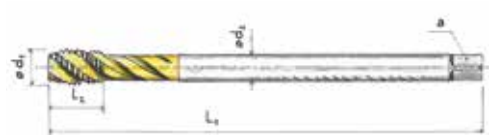

DIN
376

BA60XL02		
ISO		[m/min]
P	P.1	25-30
	P.2	20-25
N	N.2	25-30
	N.6	20-25



	d1 [mm]	P [mm]	L1 [mm]	L2 [mm]	L3 [mm]	d2 [mm]	a [mm]	z [-]	 [mm]	Verfügbarkeit Availability	Bestellbezeichnung Ordering Code
M	3	0.5	112	7	15	3.5	2.7	3	2.5	●	BA60 XL 02 M3
M	4	0.7	112	8.5	21	4.5	3.4	3	3.3	●	BA60 XL 02 M4
M	5	0.8	125	10	24.5	6	4.9	3	4.2	●	BA60 XL 02 M5
M	6	1	125	12	29	6	4.9	3	5	●	BA60 XL 02 M6
M	8	1.25	140	15	33	8	6.2	3	6.8	●	BA60 XL 02 M8
M	10	1.5	160	17.5	38	10	8	3	8.5	●	BA60 XL 02 M10
Mit Überlaufschaft with standard straight shank											
M	12	1.75	180	18	-	9	7	4	10.2	●	BA60 XL 02 M12
M	16	2	200	20.5	-	12	9	4	14	●	BA60 XL 02 M16
M	20	2.5	225	29.5	-	16	12	4	17.5	●	BA60 XL 02 M20

BA60 LH

A-Line

HSSE	TiN B+
------	-----------

M		LH	2.5xD	C	40° LSP
---	--	----	-------	---	------------

DIN 371 (M3 - M10)

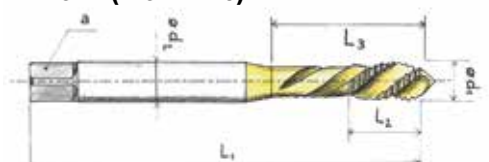

DIN 371

DIN 376 (M12 - M20)

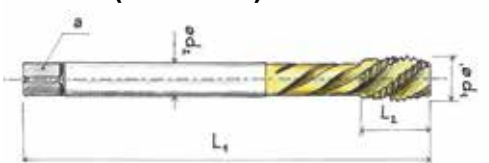

DIN 376

BA60LH02		
ISO		[m/min]
P	P.3	20-25
	P.4	15-20
	P.5	5-10
	P.7	8-10
M	M.1	8-10
K	K.2	20-25
N	N.3	25-30
	N.6	25-30



	d1 [mm]	P [mm]	L1 [mm]	L2 [mm]	L3 [mm]	d2 [mm]	a [mm]	z [-]	[mm]	Verfügbarkeit Availability	Bestellbezeichnung Ordering Code
M	3	0.5	56	7	15	3.5	2.7	3	2.5	●	BA60 LH 02 M3
M	4	0.7	63	8.5	21	4.5	3.4	3	3.3	●	BA60 LH 02 M4
M	5	0.8	70	10	24.5	6	4.9	3	4.2	●	BA60 LH 02 M5
M	6	1	80	12	29	6	4.9	3	5	●	BA60 LH 02 M6
M	8	1.25	90	15	33	8	6.2	3	6.8	●	BA60 LH 02 M8
M	10	1.5	100	17.5	38	10	8	3	8.5	●	BA60 LH 02 M10
Mit Überlaufschaft with standard straight shank											
M	12	1.75	110	18	-	9	7	4	10.2	●	BA60 LH 02 M12
M	16	2	110	20.5	-	12	9	4	14	●	BA60 LH 02 M16
M	20	2.5	140	29.5	-	16	12	4	17.5	●	BA60 LH 02 M20

BA61

A-Line

HSSE

TiN
B+

Mf

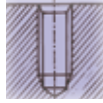

RH

2.5xD

C

40°
RSP

DIN 374

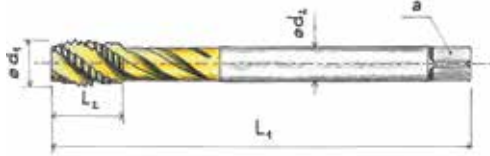

DIN
374

BA61 02		
ISO		[m/min]
P	P.3	20-25
	P.4	15-20
	P.5	5-10
	P.7	8-10
M	M.1	8-10
K	K.2	20-25
N	N.3	25-30
	N.6	25-30



	d1 [mm]	P [mm]	L1 [mm]	L2 [mm]	L3 [mm]	d2 [mm]	a [mm]	z [-]	[mm]	Verfügbarkeit Availability	Bestellbezeichnung Ordering Code
Mf	6	0.75	80	7.5	-	4.5	3.4	3	5.2	●	BA61 02 Mf 6x0.75
Mf	8	1	90	10	-	6	4.9	3	7	●	BA61 02 Mf 8x1
Mf	10	1	90	10	-	7	5.5	3	9	●	BA61 02 Mf 10x1
Mf	10	1.25	100	11.5	-	7	5.5	3	8.8	●	BA61 02 Mf 10x1.25
Mf	12	1	100	13	-	9	7	4	11	●	BA61 02 Mf 12x1
Mf	12	1.25	100	13.5	-	9	7	4	10.8	●	BA61 02 Mf 12x1.25
Mf	12	1.5	100	14	-	9	7	4	10.5	●	BA61 02 Mf 12x1.5
Mf	14	1.5	100	15.5	-	11	9	4	12.5	●	BA61 02 Mf 14x1.5
Mf	16	1.5	100	15.5	-	12	9	4	14.5	●	BA61 02 Mf 16x1.5
Mf	18	1.5	110	16	-	14	11	4	16.5	●	BA61 02 Mf 18x1.5
Mf	20	1.5	125	17	-	16	12	4	18.5	●	BA61 02 Mf 20x1.5
Mf	22	1.5	125	19	-	18	14.5	4	20.5	●	BA61 02 Mf 22x1.5
Mf	24	1.5	140	21	-	18	14.5	4	22.5	●	BA61 02 Mf 24x1.5
Mf	27	1.5	140	23	-	20	16	4	25.5	●	BA61 02 Mf 27x1.5
Mf	30	1.5	150	25	-	22	18	5	28.5	●	BA61 02 Mf 30x1.5

BA49

A-Line

HSSE

TiN
B+

G
(BSP)

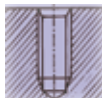

RH

2.5xD

C

40°
RSP

DIN 5156

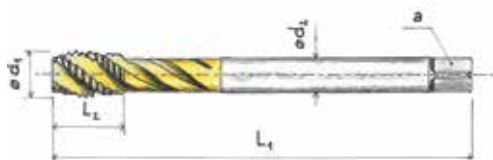

DIN
5156

BA49 02		
ISO		[m/min]
P	P.3	20-25
	P.4	15-20
	P.5	5-10
	P.7	8-10
M	M.1	8-10
K	K.2	20-25
N	N.3	25-30
	N.6	25-30



G	P [TPI]	d1 [mm]	L1 [mm]	L2 [mm]	L3 [mm]	d2 [mm]	a [mm]	z [-]	[mm]	Verfügbarkeit Availability	Bestellbezeichnung Ordering Code
1/8"	28	9.73	90	17	-	7	5.5	3	8.8	●	BA49 02 G 1/8"
1/4"	19	13.16	100	23	-	11	9	4	11.8	●	BA49 02 G 1/4"
3/8"	19	16.66	100	23	-	12	9	4	15.25	●	BA49 02 G 3/8"
1/2"	14	20.96	125	29	-	16	12	5	19	●	BA49 02 G 1/2"
5/8"	14	22.91	125	29	-	18	14.5	5	21	●	BA49 02 G 5/8"
3/4"	14	26.44	140	29	-	20	16	5	24.5	●	BA49 02 G 3/4"
7/8"	14	30.20	150	32	-	22	18	5	28.25	●	BA49 02 G 7/8"
1"	11	33.25	160	34.5	-	25	20	5	30.75	●	BA49 02 G 1"

BA50

A-Line

HSSE

TiN
B+



DIN 371 (No. 2 - 1/4)

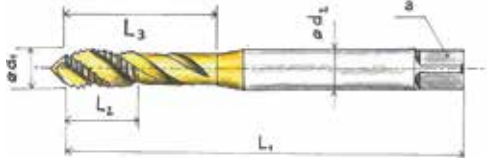

DIN
371

DIN 376 (5/16 - 1)

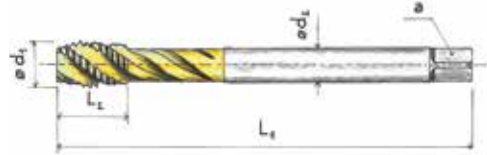

DIN
376

BA50 02		
ISO		[m/min]
P	P.3	20-25
	P.4	10-15
	P.5	5-10
	P.7	8-10
M	M.1	8-10
K	K.2	20-25
N	N.3	25-30
	N.6	25-30



UNC	P [TPI]	d1 [mm]	L1 [mm]	L2 [mm]	L3 [mm]	d2 [mm]	a [mm]	z [-]	[mm]	Verfügbarkeit Availability	Bestellbezeichnung Ordering Code
No. 2	56	2.18	45	6	13	2.8	2.1	3	1.85	●	BA50 02 UNC Nr.2
No. 3	48	2.52	50	6	15	2.8	2.1	3	2.1	●	BA50 02 UNC Nr.3
No. 4	40	2.85	56	6.5	21	3.5	2.7	3	2.35	●	BA50 02 UNC Nr.4
No. 5	40	3.18	56	6.5	21	3.5	2.7	3	2.65	●	BA50 02 UNC Nr.5
No. 6	32	3.51	56	7.5	22.5	4	3	3	2.85	●	BA50 02 UNC Nr.6
No. 8	32	4.17	63	7.5	26	4.5	3.4	3	3.5	●	BA50 02 UNC Nr.8
No.10	24	4.83	70	10	28.5	6	4.9	3	3.9	●	BA50 02 UNC Nr.10
No.12	24	5.49	80	10	28.5	6	4.9	3	4.5	●	BA50 02 UNC Nr.12
1/4	20	6.35	80	11.5	32	7	5.5	3	5.1	●	BA50 02 UNC 1/4"
Mit Überlaufschaft with standard straight shank											
5/16	18	7.94	90	13	-	6	4.9	3	6.6	●	BA50 02 UNC 5/16"
3/8	16	9.53	100	14	-	7	5.5	3	8	●	BA50 02 UNC 3/8"
7/16	14	11.11	100	17	-	8	6.2	3	9.4	●	BA50 02 UNC 7/16"
1/2	13	12.70	110	19	-	9	7	4	10.8	●	BA50 02 UNC 1/2"
9/16	12	14.29	110	21	-	11	9	4	12.2	●	BA50 02 UNC 9/16"
5/8	11	15.88	110	22.5	-	12	9	4	13.5	●	BA50 02 UNC 5/8"
3/4	10	19.05	125	26	-	14	11	4	16.5	●	BA50 02 UNC 3/4"
7/8	9	22.23	140	30	-	18	14.5	4	19.5	●	BA50 02 UNC 7/8"
1	8	25.40	160	36.5	-	18	14.5	4	22.25	●	BA50 02 UNC 1"

Bestellbeispiel Order example: 1Stück Piece BA50 02 UNC Nr.2

● Verfügbar ab Lager Available from stock
● kurzfristig lieferbar shortly available

BA51

A-Line

HSSE	TiN B+
------	-----------

UNF		RH	2.5xD	C	40° RSP
-----	--	----	-------	---	------------

DIN 371 (No. 2 - 1/4)

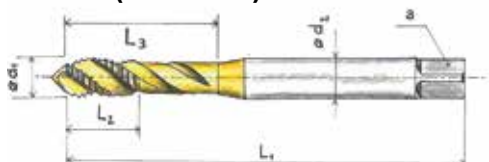

DIN 371

DIN 376 (5/16 - 1)

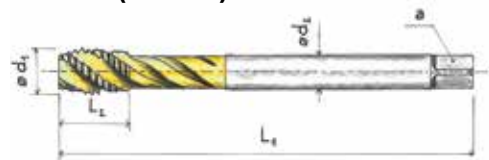

DIN 376

BA51 02		
ISO		[m/min]
P	P.3	20-25
	P.4	15-20
	P.5	5-10
	P.7	8-10
M	M.1	8-10
K	K.2	20-25
N	N.3	25-30
	N.6	25-30



UNF	P [TPI]	d1 [mm]	L1 [mm]	L2 [mm]	L3 [mm]	d2 [mm]	a [mm]	z [-]	[mm]	Verfügbarkeit Availability	Bestellbezeichnung Ordering Code
No. 2	64	2.18	45	5.5	13	2.8	2.1	3	1.85	●	BA51 02 UNF Nr.2
No. 3	56	2.52	50	6	18	2.8	2.1	3	2.15	●	BA51 02 UNF Nr.3
No. 4	48	2.85	56	6	18	3.5	2.7	3	2.4	●	BA51 02 UNF Nr.4
No. 5	44	3.18	56	6	18	3.5	2.7	3	2.7	●	BA51 02 UNF Nr.5
No. 6	40	3.51	56	6.5	22	4	3	3	2.95	●	BA51 02 UNF Nr.6
No. 8	36	4.17	63	7	26.5	4.5	3.4	3	3.5	●	BA51 02 UNF Nr.8
No.10	32	4.83	70	8	29	6	4.9	3	4.1	●	BA51 02 UNF Nr.10
No.12	28	5.49	80	9	29.5	6	4.9	3	4.6	●	BA51 02 UNF Nr.12
1/4	28	6.35	80	10	32	7	5.5	3	5.5	●	BA51 02 UNF 1/4"
Mit Überlaufschaft with standard straight shank											
5/16	24	7.94	90	11	-	6	4.9	3	6.9	●	BA51 02 UNF 5/16"
3/8	24	9.53	90	12	-	7	5.5	3	8.5	●	BA51 02 UNF 3/8"
7/16	20	11.11	100	13.5	-	8	6.2	3	9.9	●	BA51 02 UNF 7/16"
1/2	20	12.70	100	14.5	-	9	7	4	11.5	●	BA51 02 UNF 1/2"
9/16	18	14.29	100	15.5	-	11	9	4	12.9	●	BA51 02 UNF 9/16"
5/8	18	15.88	100	16	-	12	9	4	14.5	●	BA51 02 UNF 5/8"
3/4	16	19.05	110	18	-	14	11	4	17.5	●	BA51 02 UNF 3/4"
7/8	14	22.23	125	23.5	-	18	14.5	4	20.4	●	BA51 02 UNF 7/8"
1	12	25.40	140	26	-	18	14.5	4	23.25	●	BA51 02 UNF 1"

Bestellbeispiel Order example: 1Stück Piece BA51 02 UNF Nr.2

- Verfügbar ab Lager Available from stock
- kurzfristig lieferbar shortly available

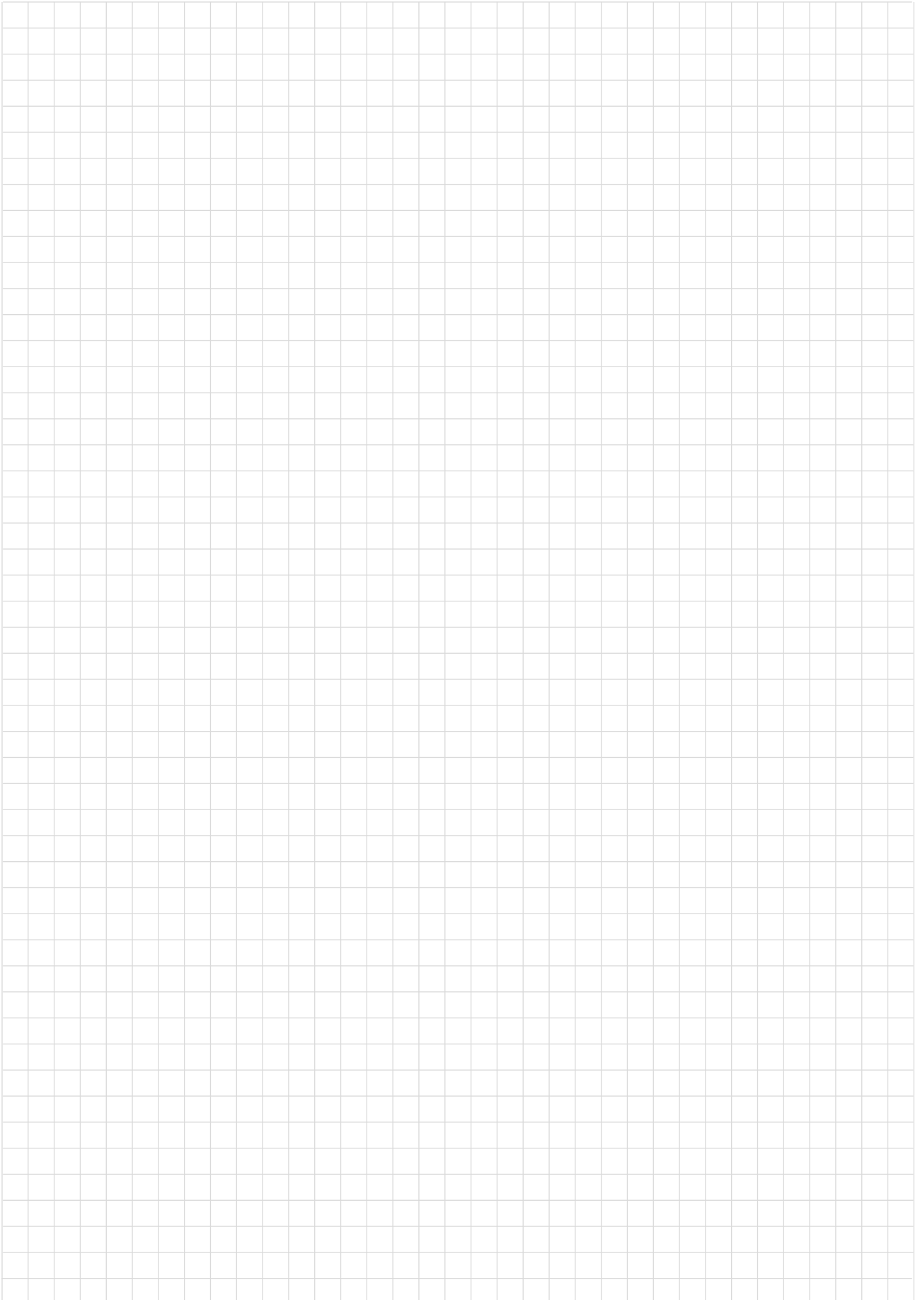

boehlerit

P-Line
Hochleistungs-
Maschinengewindebohrer
Performance tap



Maschinengewindebohrer für Durchgangsloch Taps for through holes					Maschinengewindebohrer für Grundloch Taps for blind holes			
	BP05 Metrisch metric	BP05 RC Metrisch mit Kühlung metric with coolant	BP07 Metrisch Fein metric fine	BP08 G (BSP) G (BSP)	BP60 Metrisch metric	BP60 CC Metrisch mit Kühlung metric with coolant	BP61 Metrisch Fein metric fine	BP49 G (BSP) G (BSP)
								
Seite/Page	29	30	31	32	33	34	35	36
P.1								
P.2	30-40	30-40	30-40	30-40	25-35	25-35	25-35	25-35
P.3	25-35	25-35	25-35	25-35	20-30	20-30	20-30	20-30
P.4	20-30	20-30	20-30	20-30	15-25	15-25	15-25	15-25
P.5	10-20	10-20	10-20	10-20	5-15	5-15	5-15	5-15
P.6	8-10	8-10	8-10	8-10	5-8	5-8	5-8	5-8
P.7	10-20	10-20	10-20	10-20	10-15	10-15	10-15	10-15
M.1	10-20	10-20	10-20	10-20	10-15	10-15	10-15	10-15
M.2	6-8	6-8	6-8	6-8	5-7	5-7	5-7	5-7
K.1								
K.2	25-35	25-35	25-35	25-35	20-30	20-30	20-30	20-30
K.3								
N.1								
N.2	30-40	30-40	30-40	30-40	30-40	30-40	30-40	30-40
N.3	30-40	30-40	30-40	30-40	25-35	25-35	25-35	25-35
N.4								
N.5								
N.6	25-35	25-35	25-35	25-35	25-35	25-35	25-35	25-35
N.7								
N.8								
N.9								
N.10								
S.1					10-15	10-15	10-15	10-15
S.2	12-18	12-18	12-18	12-18				
S.3					10-15	10-15	10-15	10-15
S.4	12-18	12-18	12-18	12-18				
H.1								
H.2								

Werkstoffgruppenerklärung ab Seite 78, description of material group see page 78)
 A / P / C / S - Line

BP05
P-Line



DIN 371 (M1 - M10)

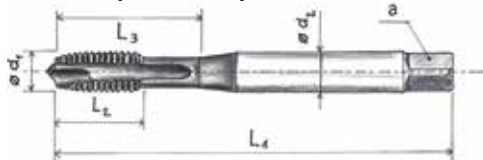

DIN 371

DIN 376 (M12 - M36)

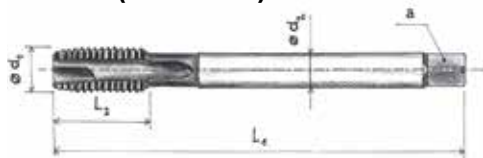

DIN 376

BP05 03		
ISO		[m/min]
P	P.3	25-35
	P.4	20-30
	P.5	10-20
	P.6	8-10
	P.7	10-20
M	M.1	10-20
	M.2	6-8
K	K.2	25-35
K	N.2	30-40
	N.3	30-40
	N.6	25-35



	d1 [mm]	P [mm]	L1 [mm]	L2 [mm]	L3 [mm]	d2 [mm]	a [mm]	z [-]	[mm]	Verfügbarkeit Availability	Bestellbezeichnung Ordering Code
M	1	0.25	40	5.5	7.5	2.5	2.1	2	0.75	○	BP05 03 M1
M	1.2	0.25	40	5.5	7.5	2.5	2.1	2	0.95	○	BP05 03 M1.2
M	1.4	0.3	40	7	10	2.5	2.1	2	1.1	○	BP05 03 M1.4
M	1.6	0.35	40	8	11	2.5	2.1	2	1.25	○	BP05 03 M1.6
M	1.8	0.35	40	8	11	2.5	2.1	2	1.45	●	BP05 03 M1.8
M	2	0.4	45	7	11	2.8	2.1	3	1.6	●	BP05 03 M2
M	2.5	0.45	50	9	15	2.8	2.1	3	2.05	●	BP05 03 M2.5
M	3	0.5	56	10	18	3.5	2.7	3	2.5	●	BP05 03 M3
M	4	0.7	63	12	21	4.5	3.4	3	3.3	●	BP05 03 M4
M	5	0.8	70	14	24.5	6	4.9	3	4.2	●	BP05 03 M5
M	6	1	80	16	29	6	4.9	3	5	●	BP05 03 M6
M	8	1.25	90	18	33	8	6.2	3	6.8	●	BP05 03 M8
M	10	1.5	100	20	36	10	8	3	8.5	●	BP05 03 M10
Mit Überlaufschaft with standard straight shank											
M	12	1.75	110	24	-	9	7	4	10.2	●	BP05 03 M12
M	14	2	110	25	-	11	9	4	12	●	BP05 03 M14
M	16	2	110	28	-	12	9	4	14	●	BP05 03 M16
M	18	2.5	125	32	-	14	11	4	15.5	●	BP05 03 M18
M	20	2.5	140	32	-	16	12	4	17.5	●	BP05 03 M20
M	24	3	160	36	-	18	14.5	4	21	●	BP05 03 M24
M	27	3	160	36	-	20	16	4	24	●	BP05 03 M27
M	30	3.5	180	40	-	22	18	4	26.5	●	BP05 03 M30
M	33	3.5	180	40	-	25	20	5	29.5	●	BP05 03 M33
M	36	4	200	55	-	28	22	5	32	●	BP05 03 M36

Bestellbeispiel Order example: 1Stück Piece BP05 03 M1

BP05 RC
P-Line

HSSE
PM

TiCN
B+



DIN 371 (M5 - M10)

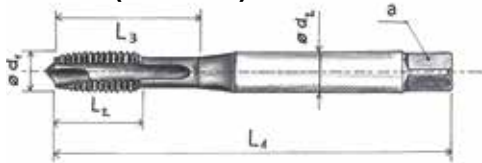

DIN
371

DIN 376 (M12 - M16)

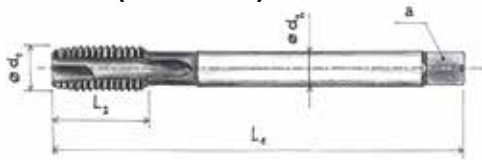

DIN
376

BP05 03 RC		
ISO		[m/min]
P	P.3	25-35
	P.4	20-30
	P.5	10-20
	P.6	8-10
	P.7	10-20
M	M.1	10-20
	M.2	6-8
K	K.2	25-35
	N.2	30-40
K	N.3	30-40
	N.6	25-35



	d1 [mm]	P [mm]	L1 [mm]	L2 [mm]	L3 [mm]	d2 [mm]	a [mm]	z [-]	⊕ [mm]	Verfügbarkeit Availability	Bestellbezeichnung Ordering Code
M	5	0.8	70	14	24.5	6	4.9	3	4.2	●	BP05 03 RC M5
M	6	1	80	16	29	6	4.9	3	5	●	BP05 03 RC M6
M	8	1.25	90	18	33	8	6.2	3	6.8	●	BP05 03 RC M8
M	10	1.5	100	20	36	10	8	3	8.5	●	BP05 03 RC M10
Mit Überlaufschaft with standard straight shank											
M	12	1.75	110	24	-	9	7	4	10.2	●	BP05 03 RC M12
M	16	2	110	28	-	12	9	4	14	●	BP05 03 RC M16

BP07
P-Line

HSSE PM	TIGN B+
------------	------------

Mf		RH	3xD	B
----	--	----	-----	---

DIN 374

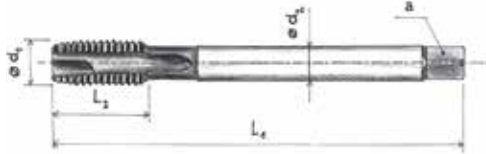

DIN
374

BP07 03		
ISO		[m/min]
P	P.3	25-35
	P.4	20-30
	P.5	10-20
	P.6	8-10
	P.7	10-20
M	M.1	10-20
	M.2	6-8
K	K.2	25-35
	N.2	30-40
K	N.3	30-40
	N.6	25-35



	d1 [mm]	P [mm]	L1 [mm]	L2 [mm]	L3 [mm]	d2 [mm]	a [mm]	z [-]	[mm]	Verfügbarkeit Availability	Bestellbezeichnung Ordering Code
Mf	8	1	90	16	-	6	4.9	3	7	●	BP07 03 Mf 8x1
Mf	10	1	90	18	-	7	5.5	3	9	●	BP07 03 Mf 10x1
Mf	10	1.25	100	18	-	7	5.5	3	8.8	●	BP07 03 Mf 10x1.25
Mf	12	1	100	22	-	9	7	4	11	●	BP07 03 Mf 12x1
Mf	12	1.25	100	22	-	9	7	4	10.8	●	BP07 03 Mf 12x1.25
Mf	12	1.5	100	22	-	9	7	4	10.5	●	BP07 03 Mf 12x1.5
Mf	14	1.5	100	22	-	11	9	4	12.5	●	BP07 03 Mf 14x1.5
Mf	16	1.5	100	22	-	12	9	4	14.5	●	BP07 03 Mf 16x1.5
Mf	18	1.5	110	25	-	14	11	4	16.5	●	BP07 03 Mf 18x1.5
Mf	20	1.5	125	25	-	16	12	4	18.5	●	BP07 03 Mf 20x1.5

Bestellbeispiel Order example: 1Stück Piece BP07 03 Mf 8x1

- Verfügbar ab Lager Available from stock
- kurzfristig lieferbar shortly available

Maschinengewindebohrer Durchgangsloch - British Standard Rohrgewinde
Machine tap through-hole - British Standard Pipe Thread

BP08
P-Line

HSSE PM	TiCN B+
--------------------------	--------------------------

G (BSP)		RH	3xD	B
--------------------------	---	-----------	------------	----------

DIN 5156

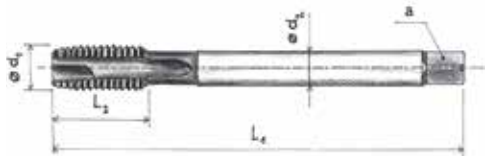

DIN
5156

BP08 03		
ISO		[m/min]
P	P.3	25-35
	P.4	20-30
	P.5	10-20
	P.6	8-10
	P.7	10-20
M	M.1	10-20
	M.2	6-8
K	K.2	25-35
K	N.2	30-40
	N.3	30-40
	N.6	25-35



G	P [TPI]	d1 [mm]	L1 [mm]	L2 [mm]	L3 [mm]	d2 [mm]	a [mm]	z [-]	 [mm]	Verfügbarkeit Availability	Bestellbezeichnung Ordering Code
1/8"	28	9.73	90	18	-	7	5.5	3	8.8	●	BP08 03 G 1/8"
1/4"	19	13.16	100	22	-	11	9	4	11.8	●	BP08 03 G 1/4"
3/8"	19	16.66	100	22	-	12	9	4	15.25	●	BP08 03 G 3/8"
1/2"	14	20.96	125	25	-	16	12	4	19	●	BP08 03 G 1/2"
5/8"	14	22.91	125	25	-	18	14.5	4	21	●	BP08 03 G 5/8"
3/4"	14	26.44	140	28	-	20	16	5	24.5	●	BP08 03 G 3/4"
1"	11	33.25	160	30	-	25	20	5	30.75	●	BP08 03 G 1"

Bestellbeispiel Order example: 1Stück Piece BP08 03 G 1/8"

- Verfügbar ab Lager Available from stock
- kurzfristig lieferbar shortly available

BP60

P-Line

HSSE PM	TIGN B+
------------	------------

M		RH	3xD	C	45° RSP
---	--	----	-----	---	------------

DIN 371 (M2 - M10)

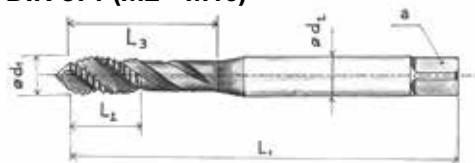

DIN
371

DIN 376 (M12 - M36)

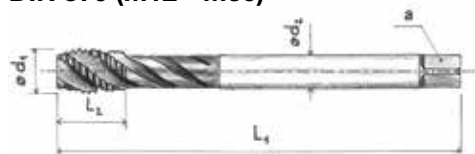

DIN
376

BP60 03		
ISO		[m/min]
P	P.3	20-30
	P.4	15-25
	P.5	5-15
	P.7	10-15
M	M.1	10-15
	M.2	5-7
K	K.2	20-30
N	N.3	25-35
	N.6	25-35
S	S.1	10-15
	S.3	10-15



	d1 [mm]	P [mm]	L1 [mm]	L2 [mm]	L3 [mm]	d2 [mm]	a [mm]	z [-]	[mm]	Verfügbarkeit Availability	Bestellbezeichnung Ordering Code
M	2	0.4	45	6	12	2.8	2.1	3	1.6	●	BP60 03 M2
M	2.5	0.45	50	6.5	15	2.8	2.1	3	2.05	●	BP60 03 M2.5
M	3	0.5	56	7	15	3.5	2.7	3	2.5	●	BP60 03 M3
M	4	0.7	63	8.5	21	4.5	3.4	3	3.3	●	BP60 03 M4
M	5	0.8	70	10	24.5	6	4.9	3	4.2	●	BP60 03 M5
M	6	1	80	12	29	6	4.9	3	5	●	BP60 03 M6
M	8	1.25	90	14	33	8	6.2	3	6.8	●	BP60 03 M8
M	10	1.5	100	17	39	10	8	3	8.5	●	BP60 03 M10
Mit Überlaufschaft with standard straight shank											
M	12	1.75	110	18	-	9	7	4	10.2	●	BP60 03 M12
M	14	2	110	20.5	-	11	9	4	12	●	BP60 03 M14
M	16	2	110	20.5	-	12	9	4	14	●	BP60 03 M16
M	18	2.5	125	25.5	-	14	11	4	15.5	●	BP60 03 M18
M	20	2.5	140	25.5	-	16	12	4	17.5	●	BP60 03 M20
M	24	3	160	32	-	18	14.5	4	21	●	BP60 03 M24
M	27	3	160	32	-	20	16	5	24	●	BP60 03 M27
M	30	3.5	180	37	-	22	18	5	26.5	●	BP60 03 M30
M	33	3.5	180	37	-	25	20	5	29.5	●	BP60 03 M33
M	36	4	200	42	-	28	22	5	32	●	BP60 03 M36

Bestellbeispiel Order example: 1Stück Piece BP60 03 M2

- Verfügbar ab Lager Available from stock
- kurzfristig lieferbar shortly available

BP60 CC

P-Line

HSSE
PM

TiCN
B+

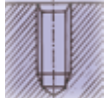
M  RH 3xD C 45° RSP CC

DIN 371 (M5 - M10)

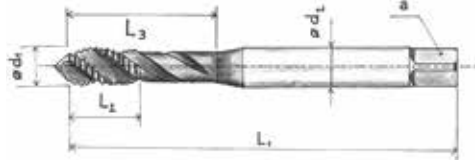

DIN
371

DIN 376 (M12 - M16)

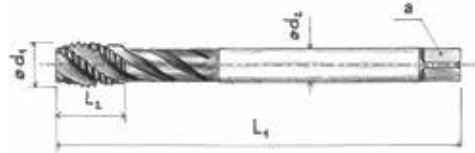

DIN
376

BP60 03 CC		
ISO		[m/min]
P	P.3	20-30
	P.4	15-25
	P.5	5-15
	P.7	10-15
M	M.1	10-15
	M.2	5-7
K	K.2	20-30
N	N.3	25-35
	N.6	25-35
S	S.1	10-15
	S.3	10-15



	d1 [mm]	P [mm]	L1 [mm]	L2 [mm]	L3 [mm]	d2 [mm]	a [mm]	z [-]	 [mm]	Verfügbarkeit Availability	Bestellbezeichnung Ordering Code
M	5	0.8	70	10	24.5	6	4.9	3	4.2	●	BP60 03 CC M5
M	6	1	80	12	29	6	4.9	3	5	●	BP60 03 CC M6
M	8	1.25	90	14	33	8	6.2	3	6.8	●	BP60 03 CC M8
M	10	1.5	100	17	39	10	8	3	8.5	●	BP60 03 CC M10
Mit Überlaufschaft with standard straight shank											
M	12	1.75	110	18	-	9	7	4	10.2	●	BP60 03 CC M12
M	14	2	110	20.5	-	11	9	4	12	●	BP60 03 CC M14
M	16	2	110	20.5	-	12	9	4	14	●	BP60 03 CC M16

BP61

P-Line

HSSE PM	TGN B+
------------	-----------

Mf		RH	3xD	C	45° RSP
----	--	----	-----	---	------------

DIN 374

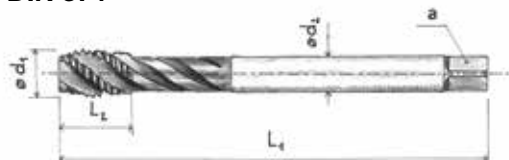

DIN
374

BP61 03		
ISO		[m/min]
P	P.3	20-30
	P.4	15-25
	P.5	5-15
	P.7	10-15
M	M.1	10-15
	M.2	5-7
K	K.2	20-30
N	N.3	25-35
	N.6	25-35
S	S.1	10-15
	S.3	10-15



	d1 [mm]	P [mm]	L1 [mm]	L2 [mm]	L3 [mm]	d2 [mm]	a [mm]	z [-]	[mm]	Verfügbarkeit Availability	Bestellbezeichnung Ordering Code
Mf	8	1	90	12	-	6	4.9	3	7	●	BP61 03 Mf 8x1
Mf	10	1	90	12	-	7	5.5	3	9	●	BP61 03 Mf 10x1
Mf	10	1.25	100	14	-	7	5.5	3	8.8	●	BP61 03 Mf 10x1.25
Mf	12	1	100	14	-	9	7	4	11	●	BP61 03 Mf 12x1
Mf	12	1.25	100	14	-	9	7	4	10.8	●	BP61 03 Mf 12x1.25
Mf	12	1.5	100	15	-	9	7	4	10.5	●	BP61 03 Mf 12x1.5
Mf	14	1.5	100	16	-	11	9	4	12.5	●	BP61 03 Mf 14x1.5
Mf	16	1.5	100	16	-	12	9	4	14.5	●	BP61 03 Mf 16x1.5
Mf	18	1.5	110	18	-	14	11	4	16.5	●	BP61 03 Mf 18x1.5
Mf	20	1.5	125	18	-	16	12	4	18.5	●	BP61 03 Mf 20x1.5

Maschinengewindebohrer Grundloch - British Standard Rohrgewinde
Machine tap blind-hole - British Standard Pipe Thread

BP49

P-Line

HSSE
PM

TICN
B+

G (BSP)  RH 3xD C 45° RSP

DIN 5156

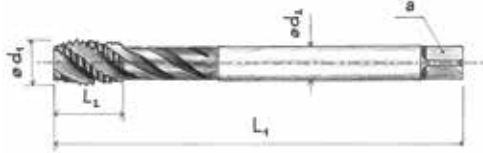

DIN
5156

BP49 03		
ISO		[m/min]
P	P.3	20-30
	P.4	15-25
	P.5	5-15
	P.7	10-15
M	M.1	10-15
	M.2	5-7
K	K.2	20-30
N	N.3	25-35
	N.6	25-35
S	S.1	10-15
	S.3	10-15



G	P [TPI]	d1 [mm]	L1 [mm]	L2 [mm]	L3 [mm]	d2 [mm]	a [mm]	z [-]	 [mm]	Verfügbarkeit Availability	Bestellbezeichnung Ordering Code
1/8"	28	9.73	90	13	-	7	5.5	3	8.8	●	BP49 03 G 1/8"
1/4"	19	13.16	100	16	-	11	9	4	11.8	●	BP49 03 G 1/4"
3/8"	19	16.66	100	16.5	-	12	9	4	15.25	●	BP49 03 G 3/8"
1/2"	14	20.96	125	20.5	-	16	12	5	19	●	BP49 03 G 1/2"
5/8"	14	22.91	125	20.5	-	18	14.5	5	21	●	BP49 03 G 5/8"
3/4"	14	26.44	140	21.5	-	20	16	5	24.5	●	BP49 03 G 3/4"
1"	11	33.25	160	25.5	-	25	20	5	30.75	●	BP49 03 G 1"

Bestellbeispiel Order example: 1Stück Piece BP49 03 G 1/8"

- Verfügbar ab Lager Available from stock
- kurzfristig lieferbar shortly available

C-Line
Maschinengewindeformer
Cold forming tap



Maschinengewindeformer Cold forming tap					
	BC70 02 HSSE Metrisch metric	BC70 02 PM Metrisch metric	BC70 05 Metrisch metric	BC70 05 CC Metrisch mit Kühlung metric with coolant	BC70 05 RC Metrisch mit Kühlung metric with coolant
					
Seite/Page	39	40	41	42	43
P.1	40-45	40-45	40-45	40-45	40-45
P.2	40-45	40-45	40-45	40-45	40-45
P.3	35-40	35-40	35-40	35-40	35-40
P.4		30-35	30-35	30-35	30-35
P.5		15-20	15-20	15-20	15-20
P.6					
P.7	15-20	15-20	15-20	15-20	15-20
M.1	15-20	15-20	15-20	15-20	15-20
M.2					
K.1					
K.2					
K.3					
N.1	40-45	40-45	40-45	40-45	40-45
N.2	40-45	40-45	40-45	40-45	40-45
N.3	35-40	35-40	35-40	35-40	35-40
N.4					
N.5	40-45	40-45	40-45	40-45	40-45
N.6	40-45	40-45	40-45	40-45	40-45
N.7					
N.8					
N.9					
N.10					
S.1					
S.2					
S.3		10-15	10-15	10-15	10-15
S.4		5-10	5-10	5-10	5-10
H.1					
H.2					

Werkstoffgruppenerklärung ab Seite 78, description of material group see page 78)
 A / P / C / S - Line

BC70 02 HSSE

C-Line



DIN 371 (M2 - M10)

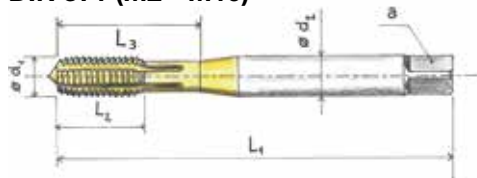

DIN 371

DIN 376 (M12 - M20)

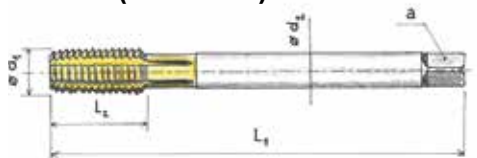

DIN 376

BC70 02 HSSE		
ISO		[m/min]
P	P.1	40-45
	P.2	40-45
	P.3	35-40
N	N.1	40-45
	N.2	40-45
	N.3	35-40
	N.5	40-45
	N.6	40-45



	d1 [mm]	P [mm]	L1 [mm]	L2 [mm]	L3 [mm]	d2 [mm]	a [mm]	z [-]	[mm]	Verfügbarkeit Availability	Bestellbezeichnung Ordering Code
M	2	0.4	45	7	11	2.8	2.1	3	1.85	●	BC70 02 HSSE M2
M	2.5	0.45	50	9	15	2.8	2.1	3	2.3	●	BC70 02 HSSE M2.5
M	3	0.5	56	10	18	3.5	2.7	4	2.8	●	BC70 02 HSSE M3
M	3.5	0.6	56	11	20	4	3	4	3.25	⊙	BC70 02 HSSE M3.5
M	4	0.7	63	12	21	4.5	3.4	5	3.7	●	BC70 02 HSSE M4
M	5	0.8	70	14	24.5	6	4.9	5	4.65	●	BC70 02 HSSE M5
M	6	1	80	16	29	6	4.9	5	5.55	●	BC70 02 HSSE M6
M	8	1.25	90	18	33	8	6.2	5	7.4	●	BC70 02 HSSE M8
M	10	1.5	100	20	36	10	8	5	9.3	●	BC70 02 HSSE M10
Mit Überlaufschaft with standard straight shank											
M	12	1.75	110	24	-	9	7	5	11.2	●	BC70 02 HSSE M12
M	14	2	110	25	-	11	9	6	13.1	●	BC70 02 HSSE M14
M	16	2	110	28	-	12	9	6	15.1	●	BC70 02 HSSE M16
M	18	2.5	125	28	-	14	11	8	16.9	●	BC70 02 HSSE M18
M	20	2.5	140	30	-	16	12	8	18.9	●	BC70 02 HSSE M20

BC70 02 PM

C-Line



DIN 371 (M2 - M10)

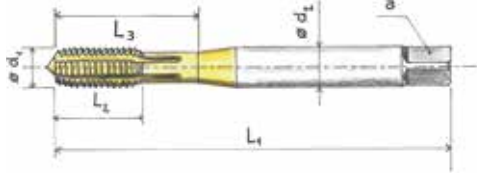

DIN 371

DIN 376 (M12 - M20)

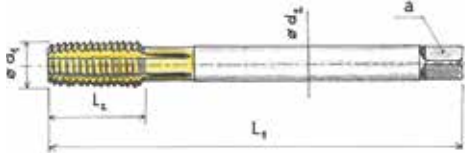

DIN 376

BC70 02 PM		
ISO		[m/min]
P	P.1	40-45
	P.2	40-45
	P.3	35-40
	P.4	30-35
	P.5	15-20
	P.7	15-20
M	M.1	15-20
N	N.1	40-45
	N.2	40-45
	N.3	35-40
	N.5	40-45
	N.6	40-45
S	S.3	10-15



	d1 [mm]	P [mm]	L1 [mm]	L2 [mm]	L3 [mm]	d2 [mm]	a [mm]	z [-]	[mm]	Verfügbarkeit Availability	Bestellbezeichnung Ordering Code
M	2	0.4	45	7	11	2.8	2.1	3	1.85	●	BC70 02 PM M2
M	2.5	0.45	50	9	15	2.8	2.1	3	2.3	●	BC70 02 PM M2.5
M	3	0.5	56	10	18	3.5	2.7	4	2.8	●	BC70 02 PM M3
M	3.5	0.6	56	11	20	4	3	4	3.25	●	BC70 02 PM M3.5
M	4	0.7	63	12	21	4.5	3.4	5	3.7	●	BC70 02 PM M4
M	5	0.8	70	14	24.5	6	4.9	5	4.65	●	BC70 02 PM M5
M	6	1	80	16	29	6	4.9	5	5.55	●	BC70 02 PM M6
M	8	1.25	90	18	33	8	6.2	5	7.4	●	BC70 02 PM M8
M	10	1.5	100	20	36	10	8	5	9.3	●	BC70 02 PM M10
Mit Überlaufschaft with standard straight shank											
M	12	1.75	110	24	-	9	7	5	11.2	●	BC70 02 PM M12
M	14	2	110	25	-	11	9	6	13.1	●	BC70 02 PM M14
M	16	2	110	28	-	12	9	6	15.1	●	BC70 02 PM M16
M	18	2.5	125	28	-	14	11	8	16.9	●	BC70 02 PM M18
M	20	2.5	140	30	-	16	12	8	18.9	●	BC70 02 PM M20

BC70

C-Line



DIN 371 (M2 - M10)

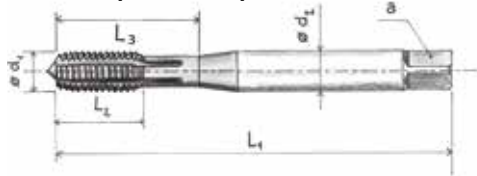

DIN 371

DIN 376 (M12 - M20)



DIN 376

BC70 05		
ISO		[m/min]
P	P.1	40-45
	P.2	40-45
	P.3	35-40
	P.4	30-35
	P.5	15-20
	P.7	15-20
M	M.1	15-20
N	N.1	40-45
	N.2	40-45
	N.3	35-40
	N.5	40-45
	N.6	40-45
S	S.3	10-15



	d1 [mm]	P [mm]	L1 [mm]	L2 [mm]	L3 [mm]	d2 [mm]	a [mm]	z [-]	[mm]	Verfügbarkeit Availability	Bestellbezeichnung Ordering Code
M	2	0.4	45	7	11	2.8	2.1	3	1.85	●	BC70 05 M2
M	2.5	0.45	50	9	15	2.8	2.1	3	2.3	●	BC70 05 M2.5
M	3	0.5	56	10	18	3.5	2.7	4	2.8	●	BC70 05 M3
M	3.5	0.6	56	11	20	4	3	4	3.25	●	BC70 05 M3.5
M	4	0.7	63	12	21	4.5	3.4	5	3.7	●	BC70 05 M4
M	5	0.8	70	14	24.5	6	4.9	5	4.65	●	BC70 05 M5
M	6	1	80	16	29	6	4.9	5	5.55	●	BC70 05 M6
M	8	1.25	90	18	33	8	6.2	5	7.4	●	BC70 05 M8
M	10	1.5	100	20	36	10	8	5	9.3	●	BC70 05 M10
Mit Überlaufschaft with standard straight shank											
M	12	1.75	110	24	-	9	7	5	11.2	●	BC70 05 M12
M	14	2	110	25	-	11	9	6	13.1	●	BC70 05 M14
M	16	2	110	28	-	12	9	6	15.1	●	BC70 05 M16
M	18	2.5	125	28	-	14	11	8	16.9	●	BC70 05 M18
M	20	2.5	140	30	-	16	12	8	18.9	●	BC70 05 M20

Bestellbeispiel Order example: 1Stück Piece BC70 05 M2

- Verfügbar ab Lager Available from stock
- kurzfristig lieferbar shortly available

BC70 05 CC

C-Line



DIN 371 (M5 - M10)

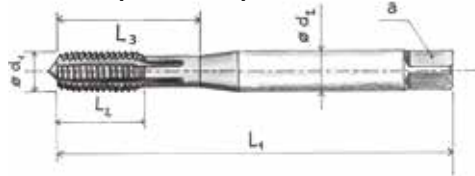

DIN 371

DIN 376 (M12 - M16)



DIN 376

BC70 05 CC		
ISO		[m/min]
P	P.1	40-45
	P.2	40-45
	P.3	35-40
	P.4	30-35
	P.5	15-20
	P.7	15-20
M	M.1	15-20
N	N.1	40-45
	N.2	40-45
	N.3	35-40
	N.5	40-45
	N.6	40-45
S	S.3	10-15



	d1 [mm]	P [mm]	L1 [mm]	L2 [mm]	L3 [mm]	d2 [mm]	a [mm]	z [-]	[mm]	Verfügbarkeit Availability	Bestellbezeichnung Ordering Code
M	5	0.8	70	14	24.5	6	4.9	5	4.65	●	BC70 05 CC M5
M	6	1	80	16	29	6	4.9	5	5.55	●	BC70 05 CC M6
M	8	1.25	90	18	33	8	6.2	5	7.4	●	BC70 05 CC M8
M	10	1.5	100	20	36	10	8	5	9.3	●	BC70 05 CC M10
Mit Überlaufschaft with standard straight shank											
M	12	1.75	110	24	-	9	7	5	11.2	●	BC70 05 CC M12
M	16	2	110	28	-	12	9	6	15.1	●	BC70 05 CC M16

BC70 05 RC

C-Line

HSSE PM	B-XT
------------	------

M		RH	3xD	C	RC
---	--	----	-----	---	----

DIN 371 (M5 - M10)

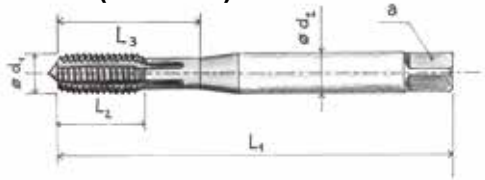

DIN 371

DIN 376 (M12 - M20)

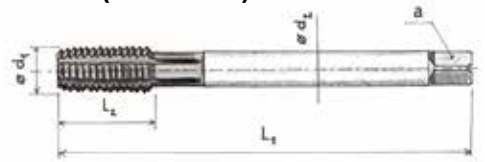

DIN 376

BC70 05 RC		
ISO		[m/min]
P	P.1	40-45
	P.2	40-45
	P.3	35-40
	P.4	30-35
	P.5	15-20
	P.7	15-20
M	M.1	15-20
N	N.1	40-45
	N.2	40-45
	N.3	35-40
	N.5	40-45
	N.6	40-45
	S	S.3



	d1 [mm]	P [mm]	L1 [mm]	L2 [mm]	L3 [mm]	d2 [mm]	a [mm]	z [-]	[mm]	Verfügbarkeit Availability	Bestellbezeichnung Ordering Code
M	5	0.8	70	14	24.5	6	4.9	5	4.65	●	BC70 05 RC M5
M	6	1	80	16	29	6	4.9	5	5.55	●	BC70 05 RC M6
M	8	1.25	90	18	33	8	6.2	5	7.4	●	BC70 05 RC M8
M	10	1.5	100	20	36	10	8	5	9.3	●	BC70 05 RC M10
Mit Überlaufschaft with standard straight shank											
M	12	1.75	110	24	-	9	7	5	11.2	●	BC70 05 RC M12
M	16	2	110	28	-	12	9	6	15.1	●	BC70 05 RC M16
M	20	2.5	140	30	-	16	12	8	18.9	●	BC70 05 RC M20

Bestellbeispiel Order example: 1Stück Piece BC70 05 RC M5



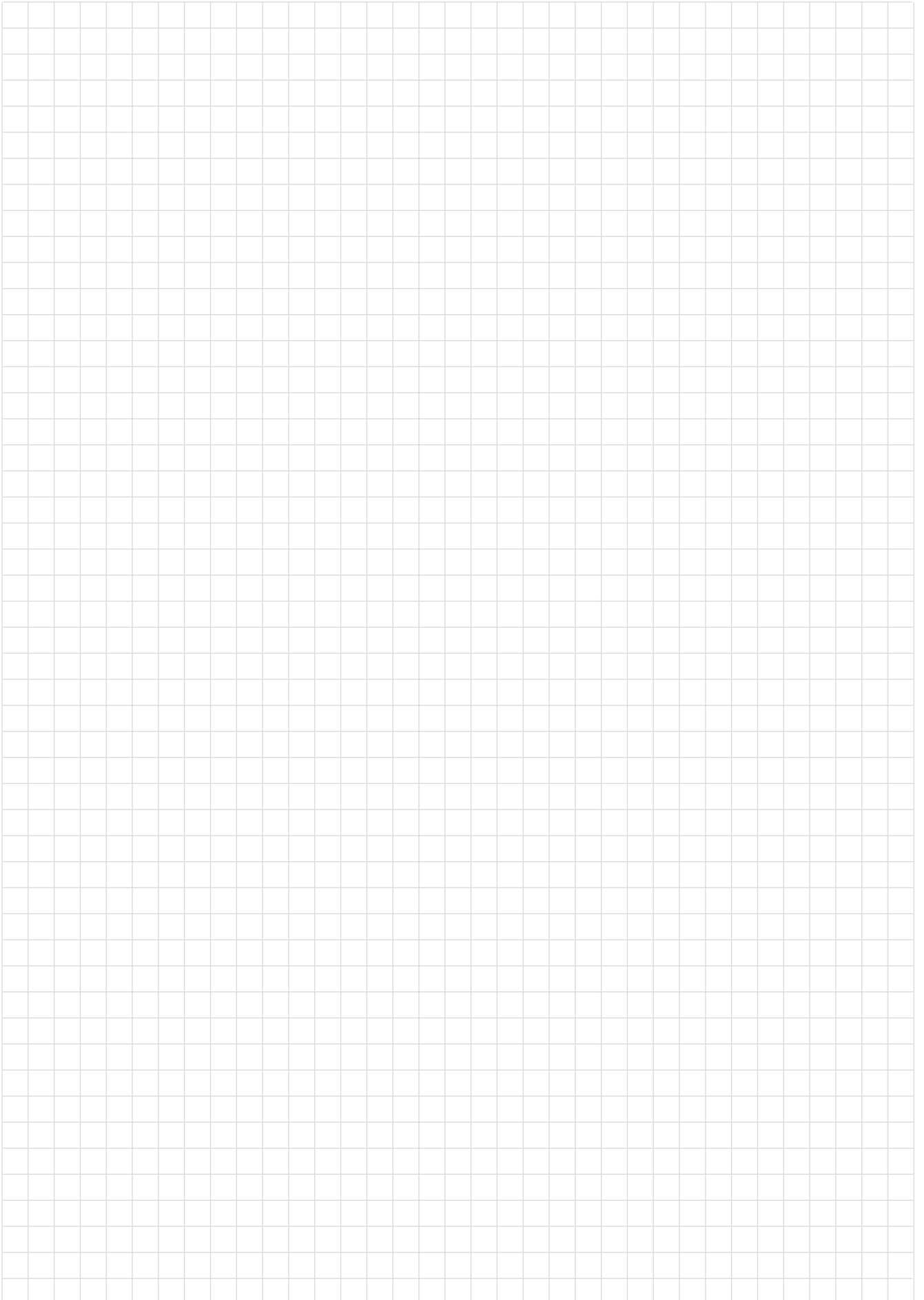



- Verfügbar ab Lager Available from stock
- kurzfristig lieferbar shortly available



boehlerit

S-Line
Schneideisen
Round die



Schneideisen Round die							
	S190 Metrisch metric	S190 Metrisch LH metric LH	S190 Metrisch vap metric vap	S191 Metrisch fein metric fine	S193 G (BSP) G (BSP)	S194 UNC UNC	S195 UNF UNF
							
Seite/Page	47	49	50	51	53	54	55
P.1	●	●	●	●	●	●	●
P.2	●	●	●	●	●	●	●
P.3	●	●	●	●	●	●	●
P.4	●	●	●	●	●	●	●
P.5							
P.6							
P.7	●	●	●	●	●	●	●
M.1	●	●	●	●	●	●	●
M.2							
K.1							
K.2	●	●	●	●	●	●	●
K.3							
N.1	●	●	●	●	●	●	●
N.2	●	●	●	●	●	●	●
N.3	●	●	●	●	●	●	●
N.4							
N.5	●	●	●	●	●	●	●
N.6	●	●	●	●	●	●	●
N.7	●	●	●	●	●	●	●
N.8							
N.9							
N.10							
S.1							
S.2							
S.3							
S.4							
H.1							
H.2							

Werkstoffgruppenerklärung ab Seite 78, description of material group see page 78)
 A / P / C / S - Line

S190
S-Line



M

RH

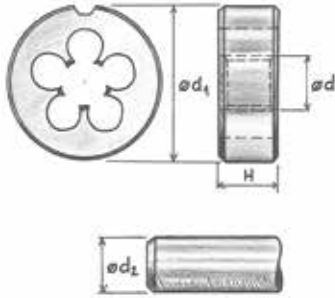

DIN 22568

S190		
ISO		
P	P.1	●
	P.2	●
	P.3	●
	P.4	●
	P.7	●
M	M.1	●
K	K.2	●
N	N.1	●
	N.2	●
	N.3	●
	N.5	●
	N.6	●
	N.7	●



	Ød [mm]	P [mm]	Ød1 [mm]	H [mm]	Bolzen Ød2 [mm]	Verfügbarkeit Availability	Bestellbezeichnung Ordering Code
M	1	0.25	16	5	0.97	●	S190 M1
M	1.1	0.25	16	5	1.07	●	S190 M1.1
M	1.4	0.3	16	5	1.36	●	S190 M1.4
M	1.6	0.35	16	5	1.54	●	S190 M1.6
M	1.7	0.35	16	5	1.64	●	S190 M1.7
M	1.8	0.35	16	5	1.74	●	S190 M1.8
M	2	0.4	16	5	1.93	●	S190 M2
M	2.2	0.45	16	5	2.13	●	S190 M2.2
M	2.3	0.4	16	5	2.23	●	S190 M2.3
M	2.5	0.45	16	5	2.47	●	S190 M2.5
M	2.6	0.45	16	5	2.53	●	S190 M2.6
M	3	0.5	20	5	2.92	●	S190 M3
M	3.5	0.6	20	5	3.41	●	S190 M3.5
M	4	0.7	20	5	3.90	●	S190 M4
M	4.5	0.75	20	7	4.40	●	S190 M4.5
M	5	0.8	20	7	4.90	●	S190 M5
M	5.5	0.9	20	7	5.39	●	S190 M5.5
M	6	1	20	7	5.88	●	S190 M6
M	7	1	25	9	6.88	●	S190 M7
M	8	1.25	25	9	7.86	●	S190 M8

Bestellbeispiel Order example: 1Stück Piece S190 M1

- Verfügbar ab Lager Available from stock
- kurzfristig lieferbar shortly available

S190

S-Line



	Ød [mm]	P [mm]	Ød1 [mm]	H [mm]	Bolzen Ød2 [mm]	Verfügbarkeit Availability	Bestellbezeichnung Ordering Code
M	9	1.25	25	9	8.86	●	S190 M9
M	10	1.5	30	11	9.85	●	S190 M10
M	12	1.75	38	14	11.83	●	S190 M12
M	14	2	38	14	13.82	●	S190 M14
M	16	2	45	18	15.82	●	S190 M16
M	18	2.5	45	18	17.79	●	S190 M18
M	20	2.5	45	18	19.79	●	S190 M20
M	22	2.5	55	22	21.79	●	S190 M22
M	24	3	55	22	23.76	●	S190 M24
M	27	3	65	25	26.76	●	S190 M27
M	30	3.5	65	25	29.73	●	S190 M30
M	33	3.5	65	25	32.73	●	S190 M33
M	36	4	65	25	35.70	●	S190 M36
M	39	4	75	30	38.70	●	S190 M39
M	42	4.5	75	30	41.68	●	S190 M42
M	45	4.5	90	36	44.68	●	S190 M45
M	48	5	90	36	47.66	●	S190 M48
M	52	5	90	36	51.66	●	S190 M52
M	56	5.5	105	36	55.62	●	S190 M56
M	60	5.5	105	36	59.62	●	S190 M60
M	64	6	120	36	63.58	●	S190 M64
M	68	6	120	36	67.58	●	S190 M68

S190

S-Line

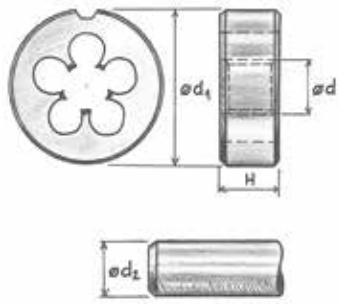

DIN
22568

S190 L		
ISO		
P	P.1	●
	P.2	●
	P.3	●
	P.4	●
	P.7	●
M	M.1	●
K	K.2	●
N	N.1	●
	N.2	●
	N.3	●
	N.5	●
	N.6	●
	N.7	●



	Ød [mm]	P [mm]	Ød1 [mm]	H [mm]	Bolzen Ød2 [mm]	Verfügbarkeit Availability	Bestellbezeichnung Ordering Code
M	2	0.4	16	5	1.93	●	S190 L M2
M	3	0.5	20	5	2.92	●	S190 L M3
M	4	0.7	20	5	3.90	●	S190 L M4
M	5	0.8	20	7	4.90	●	S190 L M5
M	6	1	20	7	5.88	●	S190 L M6
M	7	1	25	9	6.88	●	S190 L M7
M	8	1.25	25	9	7.86	●	S190 L M8
M	9	1.25	25	9	8.86	●	S190 L M9
M	10	1.5	30	11	9.85	●	S190 L M10
M	12	1.75	38	14	11.83	●	S190 L M12
M	14	2	38	14	13.82	●	S190 L M14
M	16	2	45	18	15.82	●	S190 L M16
M	18	2.5	45	18	17.79	●	S190 L M18
M	20	2.5	45	18	19.79	●	S190 L M20
M	22	2.5	55	22	21.79	●	S190 L M22
M	24	3	55	22	23.76	●	S190 L M24
M	27	3	65	25	26.76	●	S190 L M27
M	30	3.5	65	25	29.73	●	S190 L M30

Bestellbeispiel Order example: 1Stück Piece S190 L M2

● Verfügbar ab Lager Available from stock
⦿ kurzfristig lieferbar shortly available

S190
S-Line

HSSE

vap

M

RH

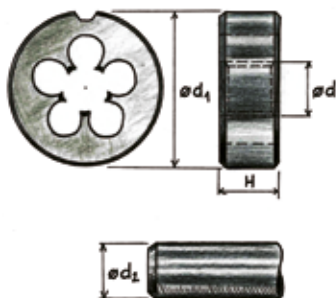

DIN
22568

S190 04		
ISO		
P	P.1	●
	P.2	●
	P.3	●
	P.4	●
	P.7	●
M	M.1	●
K	K.2	●
N	N.1	●
	N.2	●
	N.3	●
	N.5	●
	N.6	●
	N.7	●



	Ød [mm]	P [mm]	Ød1 [mm]	H [mm]	Bolzen Ød2 [mm]	Verfügbarkeit Availability	Bestellbezeichnung Ordering Code
M	3	0.5	20	5	2.92	●	S190 04 M3
M	4	0.7	20	5	3.90	●	S190 04 M4
M	5	0.8	20	7	4.90	●	S190 04 M5
M	6	1	20	7	5.88	●	S190 04 M6
M	7	1	25	9	6.88	●	S190 04 M7
M	8	1.25	25	9	7.86	●	S190 04 M8
M	10	1.5	30	11	9.85	●	S190 04 M10
M	12	1.75	38	14	11.83	●	S190 04 M12
M	14	2	38	14	13.82	●	S190 04 M14
M	16	2	45	18	15.82	●	S190 04 M16
M	18	2.5	45	18	17.79	●	S190 04 M18
M	20	2.5	45	18	19.79	●	S190 04 M20
M	24	3	55	22	23.76	●	S190 04 M24

S191
S-Line



Mf

RH

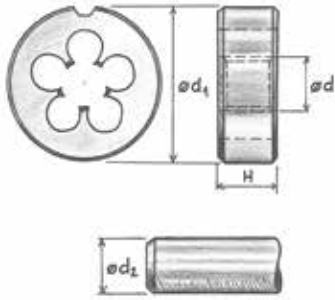

DIN
22568

S191		
ISO		
P	P.1	●
	P.2	●
	P.3	●
	P.4	●
	P.7	●
M	M.1	●
K	K.2	●
N	N.1	●
	N.2	●
	N.3	●
	N.5	●
	N.6	●
	N.7	●



	Ød [mm]	P [mm]	Ød1 [mm]	H [mm]	Bolzen Ød2 [mm]	Verfügbarkeit Availability	Bestellbezeichnung Ordering Code
Mf	4	0.5	20	5	3.92	●	S191 Mf 4x0.5
Mf	5	0.5	20	5	4.92	●	S191 Mf 5x0.5
Mf	6	0.5	20	5	5.92	●	S191 Mf 6x0.5
Mf	6	0.75	20	7	5.90	●	S191 Mf 6x0.75
Mf	7	0.75	25	9	6.90	●	S191 Mf 7x0.75
Mf	8	0.75	25	9	7.90	●	S191 Mf 8x0.75
Mf	8	1	25	9	7.88	●	S191 Mf 8x1
Mf	10	0.75	30	11	9.90	●	S191 Mf 10x0.75
Mf	10	1	30	11	9.88	●	S191 Mf 10x1
Mf	10	1.25	30	11	9.86	●	S191 Mf 10x1.25
Mf	12	1	38	10	11.88	●	S191 Mf 12x1
Mf	12	1.25	38	10	11.86	●	S191 Mf 12x1.25
Mf	12	1.5	38	10	11.85	●	S191 Mf 12x1.5
Mf	14	1	38	10	13.88	●	S191 Mf 14x1
Mf	14	1.25	38	10	13.86	●	S191 Mf 14x1.25
Mf	14	1.5	38	10	13.85	●	S191 Mf 14x1.5
Mf	15	1	38	10	14.88	●	S191 Mf 15x1
Mf	15	1.5	38	10	14.85	●	S191 Mf 15x1.5
Mf	16	1	45	14	15.88	●	S191 Mf 16x1
Mf	16	1.5	45	14	15.85	●	S191 Mf 16x1.5
Mf	18	1	45	14	17.88	●	S191 Mf 18x1
Mf	18	1.5	45	14	17.85	●	S191 Mf 18x1.5
Mf	18	2	45	14	17.82	●	S191 Mf 18x2
Mf	20	1	45	14	19.88	●	S191 Mf 20x1

Bestellbeispiel Order example: 1Stück Piece S191 Mf 4x0.5

● Verfügbar ab Lager Available from stock
○ kurzfristig lieferbar shortly available

S191
S-Line



	Ød [mm]	P [mm]	Ød1 [mm]	H [mm]	Bolzen Ød2 [mm]	Verfügbarkeit Availability	Bestellbezeichnung Ordering Code
Mf	20	1.5	45	14	19.85	●	S191 Mf 20x1.5
Mf	20	2	45	14	19.82	●	S191 Mf 20x2
Mf	22	1	55	16	21.88	●	S191 Mf 22x1
Mf	22	1.5	55	16	21.85	●	S191 Mf 22x1.5
Mf	22	2	55	16	21.82	●	S191 Mf 22x2
Mf	24	1	55	16	23.88	●	S191 Mf 24x1
Mf	24	1.5	55	16	23.85	●	S191 Mf 24x1.5
Mf	24	2	55	16	23.82	●	S191 Mf 24x2
Mf	25	1.5	55	16	24.85	●	S191 Mf 25x1.5
Mf	26	1.5	55	16	25.85	●	S191 Mf 26x1.5
Mf	27	1.5	65	18	26.85	●	S191 Mf 27x1.5
Mf	27	2	65	18	26.82	●	S191 Mf 27x2
Mf	28	1.5	65	18	27.85	●	S191 Mf 28x1.5
Mf	28	2	65	18	27.82	●	S191 Mf 28x2
Mf	30	1	65	18	29.88	●	S191 Mf 30x1
Mf	30	1.5	65	18	29.85	●	S191 Mf 30x1.5
Mf	30	2	65	18	29.82	●	S191 Mf 30x2
Mf	32	1.5	65	18	31.85	●	S191 Mf 32x1.5
Mf	33	1.5	65	18	32.85	●	S191 Mf 33x1.5
Mf	33	2	65	18	32.82	●	S191 Mf 33x2
Mf	35	1.5	65	18	34.85	●	S191 Mf 35x1.5
Mf	36	1.5	65	18	35.85	●	S191 Mf 36x1.5
Mf	36	2	65	18	35.82	●	S191 Mf 36x2
Mf	36	3	65	25	35.76	●	S191 Mf 36x3

S193
S-Line

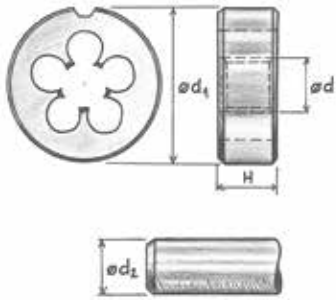

DIN
24231

S193		
ISO		
P	P.1	●
	P.2	●
	P.3	●
	P.4	●
	P.7	●
M	M.1	●
K	K.2	●
N	N.1	●
	N.2	●
	N.3	●
	N.5	●
	N.6	●
	N.7	●



	tpi	Ød [mm]	Ød1 [mm]	H [mm]	Bolzen Ød2	Verfügbarkeit Availability	Bestellbezeichnung Ordering Code
G	28	9.728	30	11	9.62	●	S193 G 1/8"
G	19	13.157	38	10	13.03	●	S193 G 1/4"
G	19	16.662	45	14	16.54	●	S193 G 3/8"
G	14	20.955	45	14	20.81	●	S193 G 1/2"
G	14	22.911	55	16	22.77	●	S193 G 5/8"
G	14	26.441	55	16	26.30	●	S193 G 3/4"
G	14	30.201	65	18	30.06	●	S193 G 7/8"
G	11	33.249	65	18	33.07	●	S193 G 1"
G	11	37.90	75	20	37.72	●	S193 G 1.1/8"
G	11	41.91	75	20	41.73	●	S193 G 1.1/4"
G	11	44.32	90	22	44.14	●	S193 G 1.3/8"
G	11	47.803	90	22	47.62	●	S193 G 1.1/2"
G	11	53.75	90	22	53.57	●	S193 G 1.3/4"
G	11	59.614	105	22	59.43	●	S193 G 2"

Bestellbeispiel Order example: 1Stück Piece S193 G 1/8"

- Verfügbar ab Lager Available from stock
- kurzfristig lieferbar shortly available

S194
S-Line



UNC

RH

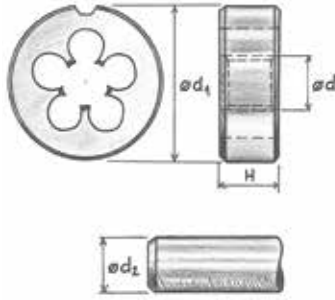

DIN
22568

S194		
ISO		
P	P.1	●
	P.2	●
	P.3	●
	P.4	●
	P.7	●
M	M.1	●
K	K.2	●
N	N.1	●
	N.2	●
	N.3	●
	N.5	●
	N.6	●
	N.7	●



	tpi	Ød [mm]	Ød1 [mm]	H [mm]	Bolzen Ød2 [mm]	Verfügbarkeit Availability	Bestellbezeichnung Ordering Code
UNC	56	2.184	16	5	2.12	●	S194 UNC Nr.2
UNC	48	2.515	16	5	2.44	●	S194 UNC Nr.3
UNC	40	2.845	20	5	2.76	●	S194 UNC Nr.4
UNC	40	3.175	20	5	3.09	●	S194 UNC Nr.5
UNC	32	3.505	20	7	3.41	●	S194 UNC Nr.6
UNC	32	4.166	20	7	4.07	●	S194 UNC Nr.8
UNC	24	4.826	20	7	4.71	●	S194 UNC Nr.10
UNC	24	5.486	20	7	5.37	●	S194 UNC Nr.12
UNC	20	6.35	20	7	6.22	●	S194 UNC 1/4"
UNC	18	7.938	25	9	7.80	●	S194 UNC 5/16"
UNC	16	9.525	30	11	9.37	●	S194 UNC 3/8"
UNC	14	11.113	30	11	10.95	●	S194 UNC 7/16"
UNC	13	12.7	38	14	12.52	●	S194 UNC 1/2"
UNC	12	14.288	38	14	14.10	●	S194 UNC 9/16"
UNC	11	15.875	45	18	15.68	●	S194 UNC 5/8"
UNC	10	19.05	45	18	18.84	●	S194 UNC 3/4"
UNC	9	22.225	55	22	22.00	●	S194 UNC 7/8"
UNC	8	25.4	55	22	25.16	●	S194 UNC 1"

S195
S-Line



UNF

RH

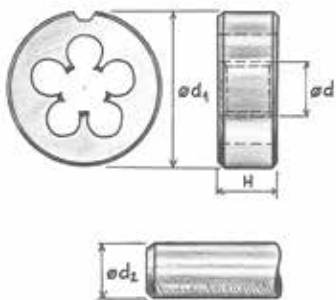

DIN
22568

S195		
ISO		
P	P.1	●
	P.2	●
	P.3	●
	P.4	●
	P.7	●
M	M.1	●
K	K.2	●
N	N.1	●
	N.2	●
	N.3	●
	N.5	●
	N.6	●
	N.7	●



	tpi	Ød [mm]	Ød1 [mm]	H [mm]	Bolzen Ød2 [mm]	Verfügbarkeit Availability	Bestellbezeichnung Ordering Code
UNF	64	2.184	16	5	2.12	●	S195 UNF Nr.2
UNF	56	2.515	16	5	2.44	●	S195 UNF Nr.3
UNF	48	2.845	20	5	2.77	●	S195 UNF Nr.4
UNF	44	3.175	20	5	3.10	●	S195 UNF Nr.5
UNF	40	3.505	20	5	3.42	●	S195 UNF Nr.6
UNF	36	4.166	20	7	4.08	●	S195 UNF Nr.8
UNF	32	4.826	20	7	4.73	●	S195 UNF Nr.10
UNF	28	5.486	20	7	5.38	●	S195 UNF Nr.12
UNF	28	6.35	20	7	6.24	●	S195 UNF 1/4"
UNF	24	7.938	25	9	7.82	●	S195 UNF 5/16"
UNF	24	9.525	30	11	9.41	●	S195 UNF 3/8"
UNF	20	11.113	30	11	10.98	●	S195 UNF 7/16"
UNF	20	12.7	38	10	12.56	●	S195 UNF 1/2"
UNF	18	14.288	38	10	14.14	●	S195 UNF 9/16"
UNF	18	15.875	45	14	15.73	●	S195 UNF 5/8"
UNF	16	19.05	45	14	18.89	●	S195 UNF 3/4"
UNF	14	22.225	55	16	22.05	●	S195 UNF 7/8"
UNF	12	25.4	55	16	25.21	●	S195 UNF 1"

bilz







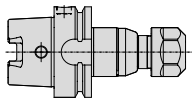















boehlerit

Spannsysteme
Clamping Systems



		
Synchro Gewindeschneid- futter Synchro Tapping Chucks		
	Seite Page	Seite Page
SCK – ESX	7 - 12	146
SCK – MMS	14 - 17	147
SCK – BZ	18 - 19	
UE – HSK	20 - 21	
SCK – Instr.	22 - 25	104-106
Zubehör Accessories	26 - 35	118-121

Zeichenerklärung Signs and symbols

 Rundlauf Concentricity	 Spanschlüssel Wrench
 Längennachstellung Length adjustment	 Dichtscheibe Sealing disc
 Längenausgleich Druck Length compensation compression	 Spannzange Collet
 Längenausgleich Zug Length compensation tension	 Schraube Screw
 achsparallele Pendelung Radial parallel float	 Mutter Collet nut
 Sicherheitskupplung Safety clutch	 Futter SBK Quick change chuck SBK
 Minimalmengenschmierung (MMS) 10bar Minimum quantity lubrication (MQL) 10 bar	 Einsatz SEK Quick change adapter SEK
 Anschnittdruckverstärker, nur bei Druckausgleich, nicht bei WFLK-Gr. 0 Hard start, only with compression, not at WFLK size 0	 Einsatz WES Quick change adapter WES
 kugelgelagert Ball carried	 Gewindegröße Thread size
 Kühlmitteldurchführung Coolant feed	 mit Querkeilschlitz with cotter slot
 Rubber-Flex® Rubber-Flex®	 Einsatz WEK Quick change adapter WEK
	 Gewindeschneidfutter Tapping chuck

Anwendung: Gewindeschneiden, -formen
auf Maschinen mit synchronisiertem Vorschub (Drehzahl/Vorschub Synchronisation, auch Rigid Tapping genannt)

Maschinentyp: Bearbeitungszentren, CNC-Drehmaschinen, Sondermaschinen mit synchronisiertem Vorschub beim Gewindeschneiden

Application: tapping, roll forming
on machines with synchronized feed (speed/feed synchronisation, also named Rigid Tapping)

Machine type: machining centres, CNC-turning and special purpose machines with synchronized feed for the tapping operation

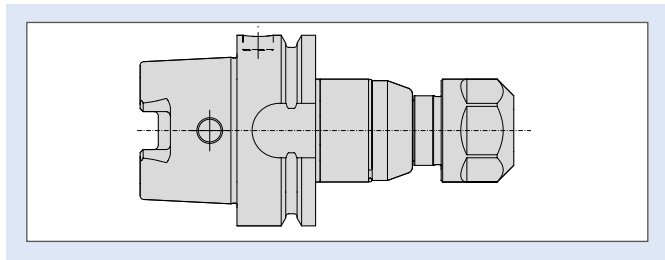

Die neueste Generation SCK- Synchrofutter wurde den aktuellen Marktanforderungen angepasst. Die Werkzeugvoreinstellung ist von Maschinenseite und Werkzeugseite aus möglich, die Schmierstoffdurchführung wurde optimiert, dadurch ist eine leckagefreie Übergabe zum Gewindebohrer gewährleistet.

Der Längenausgleich auf Druck und Zug (z. B. +/- 0,15 mm), sowie die radiale Dämpfung kompensieren kleinste Synchronisationsfehler und Lageabweichungen. Dadurch wird der Druck auf die Gewindeflanken des Werkzeuges verringert und das erforderliche Schneidmoment minimiert.

Die verwendeten Elastomere sind formstabil und beständig gegen alle Kühl-/Schmierstoffe. Durch den definierten Längenausgleich wird eine plastische Verformung der Dämpfungselemente ausgeschlossen.

Dies führt zu einem gleich bleibenden Schneidverhalten über die gesamte Lebensdauer des Werkzeuges.

Market demands have triggered the development of the new design BILZ synchro chucks. Adjustment of the chuck with regard to the taps pre-setting position can be completed from both sides of the chuck, the minimum quantity lubrication has been optimised and comes with an absolute leak free application of lubrication flow to the tap.

The tension and compression length compensation, (e.g. +/- 0,15 mm) in combination with radial dampening effect compensates small synchronisation and location anomalies.

Through this defined application compensation the user achieves reduced tap flank wear in combination with considerably less cutting loads which in turn increases tap life and is more machine friendly.

The use of the "Elastomere" dampening and length compensating elements are form-secure, they are also resistant to all coolant substances used in today's modern industries. Dampening elements remain stable due to the predetermined length compensation thus eliminating any potential plastic deformation. This results in a constant cutting condition and therefore the user benefits.

Merkmale:	Vorteile:	Nutzen:
<ul style="list-style-type: none"> • minimaler Längenausgleich auf Druck und Zug 	<ul style="list-style-type: none"> • Abbau des Druckes auf die Gewindeflanken • Kompensation von Synchronisationsfehlern 	<ul style="list-style-type: none"> • Höhere Standzeit der Gewindebohrer, geringerer Werkzeugbedarf,- verschleiß • verringerte Bruchgefahr • bessere Gewindequalität
Features:	Advantages:	Benefits:
<ul style="list-style-type: none"> • minimum compensation on tension/compression 	<ul style="list-style-type: none"> • reduction of the pressure on the thread flanks • compensation of the synchronisation error, while reversing the spindle 	<ul style="list-style-type: none"> • higher life time of the taps, less number of tools required • reduced risk of tool breakage • better thread quality

SCK – Synchrofutter für ESX-Spannzangen
SCK – Synchro chucks for ESX collets

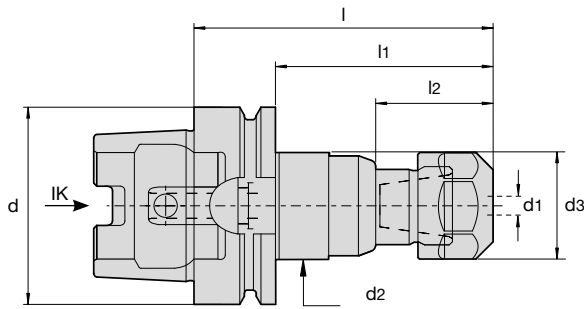

SCK/HSK-A – ESX

Bezeichnung/Id. Nr. Designation/Id. No.														
	d	d1	d2	d3	l	l1	l2							
SCK0-69/HSK-A40-ESX12-BL 5015729	+/-0,15	40	M2 – M8 2,8 – 6,0	25	25	69	49	24,5	Spanneinheiten und Ersatzteile siehe Seite 10 – 12, 26 – 29 Clamping units and components see page 10 – 12, 26 – 29	DIN902-17 6953508	EX12-Ø-IC			
SCK0-75/HSK-A50-ESX12-BL 5040620	+/-0,15	50	M2 – M8 2,8 – 6,0	25	25	75	49	24,5		DIN902-17 6953508	EX12-Ø-IC			
SCK1-89,5/HSK-A40-ESX20-BL 5053602	+/-0,15	40	M4 – M12 4,5 – 11,2	34	34	89,5	69,5	37,5		DIN 984-30 6934034	EX20-IC 6931227			
SCK1-94/HSK-A50-ESX20-BL 5052056	+/-0,15	50	M4 – M12 4,5 – 11,2	34	34	93,5	67,5	37,5		DIN 984-30 6934034	EX20-IC 6931227			
SCK1-95,5/HSK-A63-ESX20-BL 5010567	+/-0,15	63	M4 – M12 4,5 – 11,2	34	34	95,5	69,5	37,5		DIN 894-30 6934034	EX20-IC 6931227			
SCK1-160/HSK-A63-ESX20-BL 5013409	+/-0,15	63	M4 – M12 4,5 – 11,2	34	34	160	134	37,5		DIN 894-30 6934034	EX20-IC 6931227			
SCK1-100/HSK-A80-ESX20-BL 5053619	+/-0,15	80	M4 – M12 4,5 – 11,2	34	34	100	74	37,5		DIN984-30 6934034	EX20-IC 6931227			
SCK1-102/HSK-A100-ESX20-BL 5012119	+/-0,15	100	M4 – M12 4,5 – 11,2	34	34	102	73	37,5		DIN 894-30 6934034	EX20-IC 6931227			
SCK2-124/HSK-A50-ESX32-BL 5040633	+/-0,15	50	M8 – M20 6 – 18	50	50	124	104	43,5		E32 6921609	EX32-IC 6933897			
SCK2-109/HSK-A63-ESX32-BL 5011981	+/-0,15	63	M8 – M20 6 – 18	50	50	109	83	43,5		E 32 6921609	EX32-IC 6933897			
SCK2-113,5/HSK-A80-ESX32-BL 5040636	+/-0,15	80	M8 – M20 6 – 18	50	50	113,5	87,5	43,5		E32 6921609	EX32-IC 6933897			
SCK2-115,5/HSK-A100-ESX32-BL 5012062	+/-0,15	100	M8 – M20 6 – 18	50	50	115,5	86,5	43,5		E 32 6921609	EX32-IC 6933897			
SCK3-146,5/HSK-A63-ESX40-BL 5017524	+/-0,8	63	M14 – M30 11 – 22	63	58,5	146,5	120,5	50,3		E 40 6921610	EX40-IC 6948425			
SCK3-136/HSK-A80-ESX40-BL 5040638	+/-0,8	80	M14 – M30 11 – 22,0	63	58,5	136	110	50,3		E40 6021610	EX40-IC 6948425			
SCK3-138/HSK-A100-ESX40-BL 5017526	+/-0,8	100	M14 – M30 11 – 22	63	58,5	138	109	50,3		E 40 6921610	EX40-IC 6948425			
SCK4-205/HSK-A100-ESX50-BL 5085403	+/-2,0	100	M30 – M42 22 – 32	100	78	205	176	66		E 50 6951711	EX50-IC 5085410			

Kühlmittelrohr ist im Lieferumfang enthalten. Spanneinheit (Seite 10 – 12) und Spannschlüssel (Seite 26 – 29) sind nicht im Lieferumfang enthalten.
 Coolant tube included. Clamping unit (page 10 – 12) and wrench (page 26 – 29) not included.

SCK – Synchrofutter für ESX-Spannzangen
SCK – Synchro chucks for ESX collets

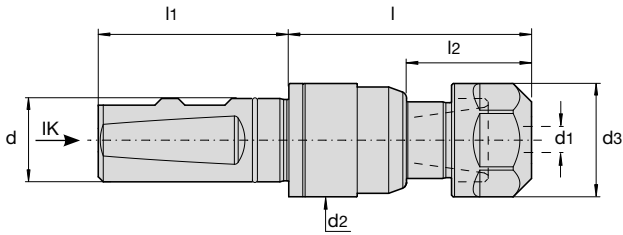

SCK/W – ESX

Bezeichnung/Id. Nr. Designation/Id. No.													
			d	d1	d2	d3	l	l1	l2				
SCK0-50/W16-ESX12-BL 5053631	+/-0,15		16	M2 – M8 2,8 – 6,0	25	25	50	49	24,5	Spanneinheiten und Ersatzteile siehe Seite 10 – 12, 26 – 29 Clamping units and components see page 10 – 12, 26 – 29	DIN902-17 6953508	EX12-Ø-IC	
SCK1-73/W20-ESX20-BL 5053635	+/-0,15		20	M4 – M12 4,5 – 11,2	34	34	73	51	37,5		DIN894-30 6934034	EX20-IC 6931227	
SCK1-73/W25-ESX20-BL 5012220	+/-0,15		25	M4 – M12 4 – 11,2	34	34	73	57	37,5		DIN 894-30 6934034	EX20-IC 6931227	
SCK2-87,5/W25-ESX32-BL 5012276	+/-0,15		25	M8 – M20 6 – 20	50	50	87,5	57	43,5		E 32 6921609	EX32-IC 6933897	
SCK3-113,5/W32-ESX40-BL 5017528	+/-0,8		32	M14 – M30 11 – 22	63	58,5	113,5	61	50,3		E 40 6921610	EX40-IC 6948425	
SCK4-176/W40-ESX50-BL 5085404	+/-2,0		40	M30 – M42 22 – 32	100	78	176	71	64		E 50 6951711	EX50-IC 5085410	

SCK0... /ESX12 werden ohne Spannmutter ausgeliefert (siehe SPE, Seite 10)
 SCK0... /ESX12 are delivered without nut (see SPE, page 10)



● kurzfristig lieferbar shortly available

SCK – Synchrofutter für ESX-Spannzangen
SCK – Synchro chucks for ESX collets

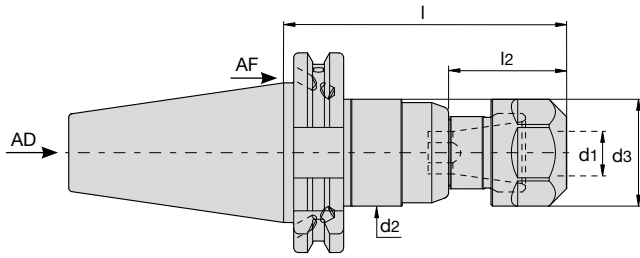

SCK/ADF – ESX (Alt/Old: DIN 69871, ADB)

Bezeichnung/Id. Nr. Designation/Id. No.				d1	d2	d3	l	l2			
SCK1-90/ADB40-ESX20-BL 5053645	+/-0,15			M4–M12 4,5–11,2	34	34	90	37,5	Spanneinheiten und Ersatzteile siehe Seite 10 – 12, 26 – 29 Clamping units and components see page 10 – 12, 26 – 29	DIN 894-30	EX20-IC
SCK1-90/ADB50-ESX20-BL 5053646	+/-0,15			M4–M12 4,5–11,2	34	34	90	37,5		DIN 894-30	EX20-IC
SCK2-101/ADB40-ESX32-BL 5053647	+/-0,15			M8–M20 6–18	50	50	101	43,5		E 32	EX32-IC
SCK2-101/ADB50-ESX32-BL 5053648	+/-0,15			M8–M20 6–18	50	50	101	43,5		E 32	EX32-IC
SCK3-123/ADB50-ESX40-BL 5053649	+/-0,8			M14–M30 11–22	63	58,5	123	50,3		E 40	EX40-IC
SCK4-212/ADB50-ESX50-BL 5085407	+/-2,0			M30 – M42 22 – 32	100	78	212	66		E 50	EX50-IC
										6934034	6931227
										6934034	6931227
										6921609	6933897
										6921609	6933897
									6921610	6948425	
									6951711	5085410	

Spanneinheit (Seite 10 – 12) und Spannschlüssel (Seite 26 – 29) sind nicht im Lieferumfang enthalten.
 Clamping unit (page 10 – 12) and wrench (page 26 – 29) not included.

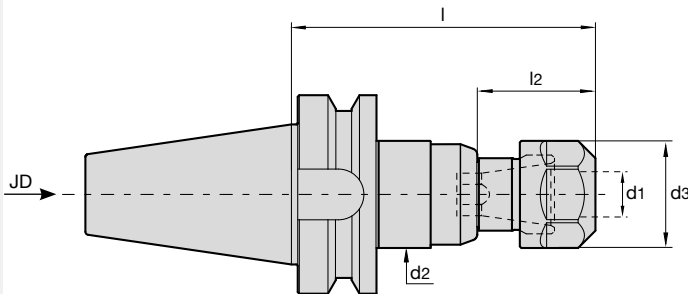

SCK/JD – ESX (Alt/Old: MAS403, BT)

Bezeichnung/Id. Nr. Designation/Id. No.				d1	d2	d3	l	l2			
SCK1-91,5/BT30-ESX20-BL 5049400	+/-0,15			M4–M12 4,5–11,2	34	34	91,5	37,5	Spanneinheiten und Ersatzteile siehe Seite 10 – 12, 26 – 29 Clamping units and components see page 10 – 12, 26 – 29	DIN984-30	EX20-IC
SCK1-96,5/BT40-ESX20-BL 5053652	+/-0,15			M4–M12 4,5–11,2	34	34	96,5	37,5		DIN 894-30	EX20-IC
SCK1-107,5/BT50-ESX20-BL 5053653	+/-0,15			M4–M12 4,5–11,2	34	34	107,5	37,5		DIN 894-30	EX20-IC
SCK2-120/BT30-ESX32-BL 5053654	+/-0,15			M8–M20 6–18	50	50	120	43,5		E 32	EX32-IC
SCK2-110/BT40-ESX32-BL 5053655	+/-0,15			M8–M20 6–18	50	50	110	43,5		E 32	EX32-IC
SCK2-121/BT50-ESX32-BL 5053656	+/-0,15			M8–M20 6–18	50	50	121	73,5		E 32	EX32-IC
SCK3-141,5/BT50-ESX40-BL 5053658	+/-0,8			M14–M30 11–22	63	58,5	141,5	50,3		E 40	EX40-IC
										6934034	6931227
										6934034	6931227
										6921609	6933897
									6921609	6933897	
									6921610	6948425	

Spanneinheit (Seite 10 – 12) und Spannschlüssel (Seite 26 – 29) sind nicht im Lieferumfang enthalten.
 Clamping unit (page 10 – 12) and wrench (page 26 – 29) not included.

● kurzfristig lieferbar shortly available

DIN 69871



DIN 69871



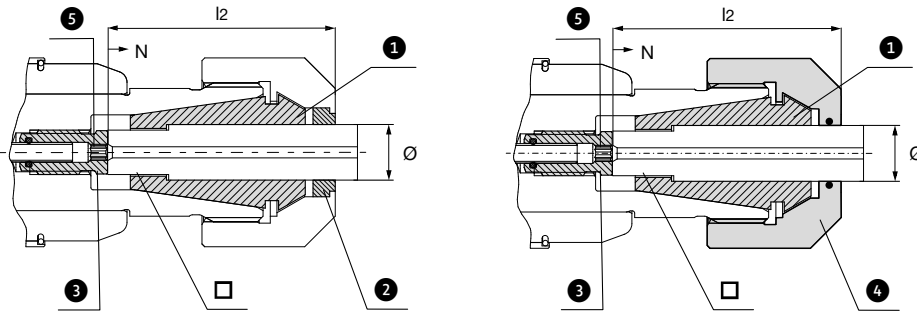

N = Nachstellung
Adjustment
 l2 = Einstecktiefe
Insert depth
 Ø = Schaftdurchmesser
Shank diameter
 □ = Schaftvierkant
Drive square

ESX DIN/ISO											
Spanneinheit – ESX Ausführung C Clamping unit ESX Version C						bestehend aus: consisting of:					
Bezeichnung/Id. Nr. Designation/Id. No.	SCK.../ ESX...	Ø x □	DIN	ISO	l2	N	1	2	3	5	
SPE4x3,2C-ESX12 5020194	SCK0/ ESX12	4 x 3,15/3,2		M4 M5	23,5	2	ESX12GB-4x3,15/3,2 5020195	EX12-4-IC 5020211	SCK010C-4x3,2 5020198	2	
SPE4,5x3,4C-ESX12 5020214		4,5 x 3,4		M4 M6	23,5		ESX12GB-4,5x3,4 5020217	EX12-4,5-IC 5020219	SCK010C-4,5x3,4 5020221		
SPE5x4C-ESX12 5020215		5,0 x 4,0		M5	24,5		ESX12GB-5x4 5020218	EX12-5-IC 5020220	SCK010C-5x4 5020222		
SPE6x4,9C-ESX12 5020216		6,0 x 4,9	M5, M6, M8		25,5		ESX12GB-6x4,9 6950826	EX12-6-IC 6952625	SCK010C-6x4,9 5020223		
SPE4,5x3,4C-ESX20 5013770		4,5 x 3,4	M4 M6		29		ESX20GB-4,5x3,4 6948389	DS/ER20-4,5 6948386	SCK110C-4,5x3,4 5013780		
SPE5x4C-ESX20 5013774		5,0 x 4,0		M5	30		ESX20GB-5x4 6949763	DS/ER20-5 6953236	SCK110C-5x4 5013781		
SPE6x4,9C-ESX20 5012479	SCK1/ ESX20	6,0 x 4,9	M5, M6, M8		31	3	ESX20GB-6x4,9 6948390	DS/ER20-6 6943901	SCK110C-6x4,9 5012783	2,5	
SPE6,3x5C-ESX20 5073202		6,3 x 5,0		M6 M8			ESX20GB-6,3x5 6951397	DS/ER20-6,5 6953031	SCK110C-6x4,9 5012783		
SPE7x5,5C-ESX20 5012480		7,0 x 5,5	M7, M9, M10				ESX20GB-7x5,5 6949767	DS/ER20-7 6950178	SCK110C-7x5,5 5012792		
SPE7,1x5,6C-ESX20 5073203		7,1 x 5,6		M9			ESX20GB-7,1x5,6 6953228	DS/ER20-7,5 6953237	SCK110C-7x5,5 5012792		
SPE8x6,2/6,3C-ESX20 5012481		8,0 x 6,2/6,3	M8 M11	M8 M10			36	ESX20GB-8x6,2/6,3 6949202	DS/ER20-8 6946991		SCK110C-8x6,2 5012793
SPE9x7/7,1C-ESX20 5012482		9,0 x 7,0/7,1	M9 M12	M12			37	ESX20GB-9x7/7,1 6947338	DS/ER20-9 6947339		SCK110C-9x7 5012796
SPE10x8C-ESX20 5012483		10,0 x 8,0	M10	M10			41	ESX20GB-10x8 6949111	DS/ER20-10 6931347		SCK110C-10x8 5012809
SPE11x9C-ESX20 5013775		11,0 x 9,0	M14				42	ESX20GB-11x9 6949177	DS/ER20-11 6944294		SCK110C-11x9 5013782
SPE11,2x9C-ESX20 5035343		11,2 x 9,0						ESX20GB-11,2x9 6949353	DS/ER20-11,5 6953239		SCK110C-11x9 5013782
SPE6x4,9C-ESX32 5013821		SCK2/ ESX32	6,0 x 4,9	M5, M6, M8				31	3		ESX32GB-6x4,9 6949997
SPE6,3x5C-ESX32 5073204	6,3 x 5,0				ESX32GB-6,3x5 6946964	DS/ER32-6,5 6954198	SCK210C-6x4,9 5013824				
SPE7x5,5C-ESX32 5013822	7,0 x 5,5		M7, M9, M10		ESX32GB-7x5,5 6950029	DS/ER32-7 6953637	SCK210C-7x5,5 5013825				
SPE7,1x5,6C-ESX32 5073205	7,1 x 5,6				ESX32GB-7,1x5,6 6951552	DS/ER32-7,5 6954199	SCK210C-7x5,5 5013825				
SPE8x6,2/6,3C-ESX32 5013823	8,0 x 6,2/6,3		M8 M11	M8 M10	36	ESX32GB-8x6,2/6,3 6949769	DS/ER32-8 6949999			SCK210C-8x6,2 5013826	
SPE9x7/7,1C-ESX32 5012485	9,0 x 7,0/7,1		M9 M12	M12	37	ESX32GB-9x7/7,1 6946965	DS/ER32-9 6949298			SCK210C-9x7 5012864	
SPE10x8C-ESX32 5012486	10,0 x 8,0		M10	M10	41	ESX32GB-10x8 6949998	DS/ER32-10 6948675			SCK210C-10x8 5012868	
SPE11x9C-ESX32 5012487	11,0 x 9,0		M14		42	ESX32GB-11x9 6946104	DS/ER32-11 6948387			SCK210C-11x9 5012869	
SPE11,2x9C-ESX32 5073206	11,2 x 9,0					ESX32GB-11,2x9 6951219	DS/ER32-11,5 6951274			SCK210C-11x9 5012869	



● kurzfristig lieferbar shortly available

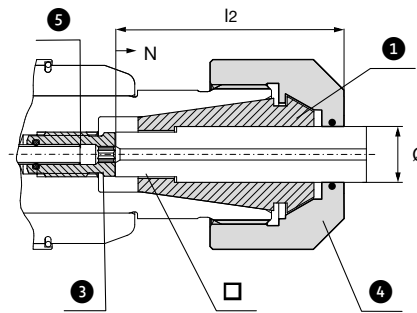
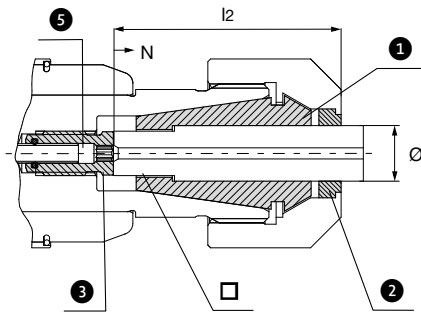

N = Nachstellung
 Adjustment
 l2 = Einstecktiefe
 Insert depth
 Ø = Schaftdurchmesser
 Shank diameter
 □ = Schaftvierkant
 Drive square



ESX DIN/ISO												
Spanneinheit – ESX Ausführung C Clamping unit ESX Version C						bestehend aus: consisting of:						
Bezeichnung/Id. Nr. Designation/Id. No.	SCK.../ ESX...	Ø x □	DIN	ISO	l2	N	1	2	3	5		
SPE12x9C-ESX32 5012488	SCK2/ ESX32	12,0 x 9,0	M12 M16		42	3	ESX32GB-12x9 6946106	DS/ER32-12 6946689	SCK210C-11x9 5012869	3		
SPE14x11/11,2C-ESX32 5012489		14,0 x 11,0/11,2	M18	M18	44		ESX32GB-14x11/11,2 6947337	DS/ER32-14 6946613	SCK210C-14x11 5012870			
SPE16x12/12,5C-ESX32 5012490		16,0 x 12,0/12,5	M20	M22	45		ESX32GB-16x12/12,5 6948391	DS/ER32-16 6946822	SCK210C-16x12 5012871			
SPE18x14,5C-ESX32 5013787		18,0 x 14,5	M22		47		ESX32GB-18x14,5 6950206	DS/ER32-18 6946002	SCK210C-18x14,5 5013789			
SPE10x8C-ESX40 5016652		10,0 x 8,0	M10	M10	41		ESX40GB-10x8 9080012	DS/ER40-10 6952199	SCK310C-10x8 5016661			
SPE11x9C-ESX40 5016653	SCK3/ ESX40	11,0 x 9,0	M14		42	ESX40GB-11x9 6955398	DS/ER40-11 6954278	SCK310C-11x9 5016662	4			
SPE11,2x9C-ESX40 5073207		11,2 x 9		M14		ESX40GB-11,2x9 5069535	DS/ER40-11,5 6954279	SCK310C-11x9 5016662				
SPE12x9C-ESX40 5016654		12,0 x 9,0	M12 M16			ESX40GB-12x9 9074741	DS/ER40-12 6954280	SCK310C-11x9 5016662				
SPE14x11/11,2C-ESX40 5016655		14,0 x 11,0/11,2	M18	M18		44	ESX40GB-14x11/11,2 9074742	DS/ER40-14 6954284		SCK310C-14x11 5016663		
SPE16x12/12,5C-ESX40 5016656		16,0 x 12,0/12,5	M20	M22		45	ESX40GB-16x12/12,5 9080073	DS/ER40-16 6946054		SCK310C-16x12 5016664		
SPE18x14,5C-ESX40 5016657		18,0 x 14,5	M22			47	ESX40GB-18x14,5 6952207	DS/ER40-18 6946120		SCK310C-18x14,5 5016665		
SPE20x16C-ESX40 5016658		20,0 x 16,0	M27	M27 M30		52	ESX40GB-20x16 6948903	DS/ER40-20 6952971		SCK310C-20x16 5016666		
SPE22x18C-ESX40 5016659		22,0 x 18,0	M30			54	ESX40GB-22x18 6949124	DS/ER40-22 6949887		SCK310C-22x18 5016667		
SPE22x18C-ESX50 5085426		SCK4/ ESX50	22 x 18	M30			69	ESX50GB-22x18 5065799		DS/ER50-22 5085415	SCK410-1-BZ53/3 5088463	6
SPE25x20C-ESX50 5085427			25 x 20	M33			71	ESX50GB-25x20 5065800		DS/ER50-25 5085420		
SPE28x22C-ESX50 5085428	28 x 22		M36		73	ESX50GB-28x22 5065801	DS/ER50-28 5085421					
SPE32x24C-ESX50 5085429	32 x 24		M39 M42		75	ESX50GB-32x24 5065802	DS/ER50-32 5085422					

● kurzfristig lieferbar shortly available

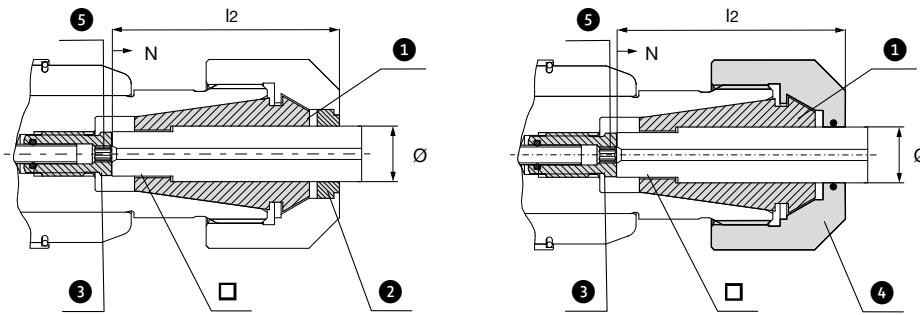

N = Nachstellung
Adjustment
l2 = Einstecktiefe
Insert depth
Ø = Schaftdurchmesser
Shank diameter
□ = Schaftvierkant
Drive square

ESX DIN/ISO

Spanneinheit – ESX Ausführung C Clamping unit ESX Version C

bestehend aus: consisting of:

Bezeichnung/Id. Nr. Designation/Id. No.	SCK.../ ESX...	Ø x □	DIN	ISO	l2	N	1	2	3	5	
SPE4x3,2C-ESX12 5020194	SCK0/ ESX12	4 x 3,15/3,2		M4 M5	23,5	2	ESX12GB-4x3,15/3,2 5020195	EX12-4-IC 5020211	SCK010C-4x3,2 5020198	2	
SPE4,5x3,4C-ESX12 5020214		4,5 x 3,4	M4 M6		23,5		ESX12GB-4,5x3,4 5020217	EX12-4,5-IC 5020219	SCK010C-4,5x3,4 5020221		
SPE5x4C-ESX12 5020215		5,0 x 4,0		M5	24,5		ESX12GB-5x4 5020218	EX12-5-IC 5020220	SCK010C-5x4 5020222		
SPE6x4,9C-ESX12 5020216		6,0 x 4,9	M5, M6, M8		25,5		ESX12GB-6x4,9 6950826	EX12-6-IC 6952625	SCK010C-6x4,9 5020223		
SPE4,5x3,4C-ESX20 5013770		4,5 x 3,4	M4 M6		29		ESX20GB-4,5x3,4 6948389	DS/ER20-4,5 6948386	SCK110C-4,5x3,4 5013780		
SPE5x4C-ESX20 5013774		5,0 x 4,0		M5	30		ESX20GB-5x4 6949763	DS/ER20-5 6953236	SCK110C-5x4 5013781		
SPE6x4,9C-ESX20 5012479	SCK1/ ESX20	6,0 x 4,9	M5, M6, M8		31	3	ESX20GB-6x4,9 6948390	DS/ER20-6 6943901	SCK110C-6x4,9 5012783	2,5	
SPE6,3x5C-ESX20 5073202		6,3 x 5,0	M6 M8				ESX20GB-6,3x5 6951397	DS/ER20-6,5 6953031	SCK110C-6x4,9 5012783		
SPE7x5,5C-ESX20 5012480		7,0 x 5,5	M7, M9, M10				ESX20GB-7x5,5 6949767	DS/ER20-7 6950178	SCK110C-7x5,5 5012792		
SPE7,1x5,6C-ESX20 5073203		7,1 x 5,6		M9			ESX20GB-7,1x5,6 6953228	DS/ER20-7,5 6953237	SCK110C-7x5,5 5012792		
SPE8x6,2/6,3C-ESX20 5012481		8,0 x 6,2/6,3	M8 M11 M10	M8 M10			36	ESX20GB-8x6,2/6,3 6949202	DS/ER20-8 6946991		SCK110C-8x6,2 5012793
SPE9x7/7,1C-ESX20 5012482		9,0 x 7,0/7,1	M9 M12	M12			37	ESX20GB-9x7/7,1 6947338	DS/ER20-9 6947339		SCK110C-9x7 5012796
SPE10x8C-ESX20 5012483		10,0 x 8,0	M10	M10			41	ESX20GB-10x8 6949111	DS/ER20-10 6931347		SCK110C-10x8 5012809
SPE11x9C-ESX20 5013775		11,0 x 9,0	M14				42	ESX20GB-11x9 6949177	DS/ER20-11 6944294		SCK110C-11x9 5013782
SPE11,2x9C-ESX20 5035343		11,2 x 9,0						ESX20GB-11,2x9 6949353	DS/ER20-11,5 6953239		SCK110C-11x9 5013782
SPE6x4,9C-ESX32 5013821		SCK2/ ESX32	6,0 x 4,9	M5, M6, M8				31	3		ESX32GB-6x4,9 6949997
SPE6,3x5C-ESX32 5073204	6,3 x 5,0				ESX32GB-6,3x5 6946964	DS/ER32-6,5 6954198	SCK210C-6x4,9 5013824				
SPE7x5,5C-ESX32 5013822	7,0 x 5,5		M7, M9, M10		ESX32GB-7x5,5 6950029	DS/ER32-7 6953637	SCK210C-7x5,5 5013825				
SPE7,1x5,6C-ESX32 5073205	7,1 x 5,6				ESX32GB-7,1x5,6 6951552	DS/ER32-7,5 6954199	SCK210C-7x5,5 5013825				
SPE8x6,2/6,3C-ESX32 5013823	8,0 x 6,2/6,3		M8 M11 M10	M8 M10	36	ESX32GB-8x6,2/6,3 6949769	DS/ER32-8 6949999			SCK210C-8x6,2 5013826	
SPE9x7/7,1C-ESX32 5012485	9,0 x 7,0/7,1		M9 M12	M12	37	ESX32GB-9x7/7,1 6946965	DS/ER32-9 6949298			SCK210C-9x7 5012864	
SPE10x8C-ESX32 5012486	10,0 x 8,0		M10	M10	41	ESX32GB-10x8 6949998	DS/ER32-10 6948675			SCK210C-10x8 5012868	
SPE11x9C-ESX32 5012487	11,0 x 9,0		M14		42	ESX32GB-11x9 6946104	DS/ER32-11 6948387			SCK210C-11x9 5012869	
SPE11,2x9C-ESX32 5073206	11,2 x 9,0					ESX32GB-11,2x9 6951219	DS/ER32-11,5 6951274			SCK210C-11x9 5012869	



● kurzfristig lieferbar shortly available

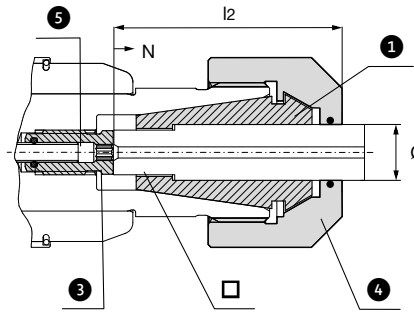
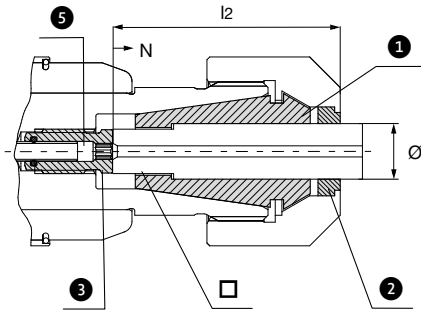

N = Nachstellung
Adjustment
l2 = Einstecktiefe
Insert depth
Ø = Schaftdurchmesser
Shank diameter
□ = Schaftvierkant
Drive square



ESX DIN/ISO													
Spanneinheit – ESX Ausführung C Clamping unit ESX Version C						bestehend aus: consisting of:							
Bezeichnung/Id. Nr. Designation/Id. No.	SCK.../ ESX...	Ø x □	DIN	ISO	l2	N	1	2	3	5			
SPE12x9C-ESX32 5012488	SCK2/ ESX32	12,0 x 9,0	M12		42	3	ESX32GB-12x9 6946106	DS/ER32-12 6946689	SCK210C-11x9 5012869	3			
SPE14x11/11,2C-ESX32 5012489		14,0 x 11,0/11,2	M18	M18	44		ESX32GB-14x11/11,2 6947337	DS/ER32-14 6946613	SCK210C-14x11 5012870				
SPE16x12/12,5C-ESX32 5012490		16,0 x 12,0/12,5	M20	M22	45		ESX32GB-16x12/12,5 6948391	DS/ER32-16 6946822	SCK210C-16x12 5012871				
SPE18x14,5C-ESX32 5013787		18,0 x 14,5	M22		47		ESX32GB-18x14,5 6950206	DS/ER32-18 6946002	SCK210C-18x14,5 5013789				
SPE10x8C-ESX40 5016652		10,0 x 8,0	M10	M10	41		ESX40GB-10x8 9080012	DS/ER40-10 6952199	SCK310C-10x8 5016661				
SPE11x9C-ESX40 5016653	SCK3/ ESX40	11,0 x 9,0	M14		42	3	ESX40GB-11x9 6955398	DS/ER40-11 6954278	SCK310C-11x9 5016662	4			
SPE11,2x9C-ESX40 5073207		11,2 x 9		M14			ESX40GB-11,2x9 5069535	DS/ER40-11,5 6954279	SCK310C-11x9 5016662				
SPE12x9C-ESX40 5016654		12,0 x 9,0	M12	M16	44		ESX40GB-12x9 9074741	DS/ER40-12 6954280	SCK310C-11x9 5016662				
SPE14x11/11,2C-ESX40 5016655		14,0 x 11,0/11,2	M18	M18			ESX40GB-14x11/11,2 9074742	DS/ER40-14 6954284	SCK310C-14x11 5016663				
SPE16x12/12,5C-ESX40 5016656		16,0 x 12,0/12,5	M20	M22	45		ESX40GB-16x12/12,5 9080073	DS/ER40-16 6946054	SCK310C-16x12 5016664				
SPE18x14,5C-ESX40 5016657		18,0 x 14,5	M22		47		ESX40GB-18x14,5 6952207	DS/ER40-18 6946120	SCK310C-18x14,5 5016665				
SPE20x16C-ESX40 5016658		20,0 x 16,0	M27	M27 M30	52		ESX40GB-20x16 6948903	DS/ER40-20 6952971	SCK310C-20x16 5016666				
SPE22x18C-ESX40 5016659		22,0 x 18,0	M30		54		ESX40GB-22x18 6949124	DS/ER40-22 6949887	SCK310C-22x18 5016667				
SPE22x18C-ESX50 5085426		SCK4/ ESX50	22 x 18	M30			69	4	ESX50GB-22x18 5065799		DS/ER50-22 5085415	SCK410-1-BZ53/3 5088463	6
SPE25x20C-ESX50 5085427			25 x 20	M33			71		ESX50GB-25x20 5065800		DS/ER50-25 5085420		
SPE28x22C-ESX50 5085428	28 x 22		M36		73	ESX50GB-28x22 5065801	DS/ER50-28 5085421						
SPE32x24C-ESX50 5085429	32 x 24		M39 M42		75	ESX50GB-32x24 5065802	DS/ER50-32 5085422						

bilz

boehlerit

STA Synchronersatz

Verwendung in Spannzangenaufnahmen
nach ISO 15488 (DIN6499)





Der neue STA Synchroeinsatz (**Synchro Tapping Adaptor**) wurde speziell für Spannzangenaufnahmen entwickelt und ermöglicht Gewinden und Formen auf Maschinen mit synchronisierter Spindel.

Merkmale:

- Kühlschmierstoff geeignet
- Minimallängenausgleich auf Druck und Zug
- optimale Dämpfung
- kompakte Bauweise
- ermöglicht Schnellwechslung des Werkzeuges

VORTEILE:

- Abbau der axialen Kräfte auf die Gewindeflanken
- Kompensation von Synchronisationsfehlern
- wartungsarm
- einsetzbar bei engen Spindelräumen

NUTZEN:

- deutliche Standzeiterhöhung und Prozesssicherheit
- bessere Gewindequalität
- verringerte Werkzeugbruchgefahr
- Kostenersparnis durch geringeren Werkzeugbedarf
- geringere Spindelwartung

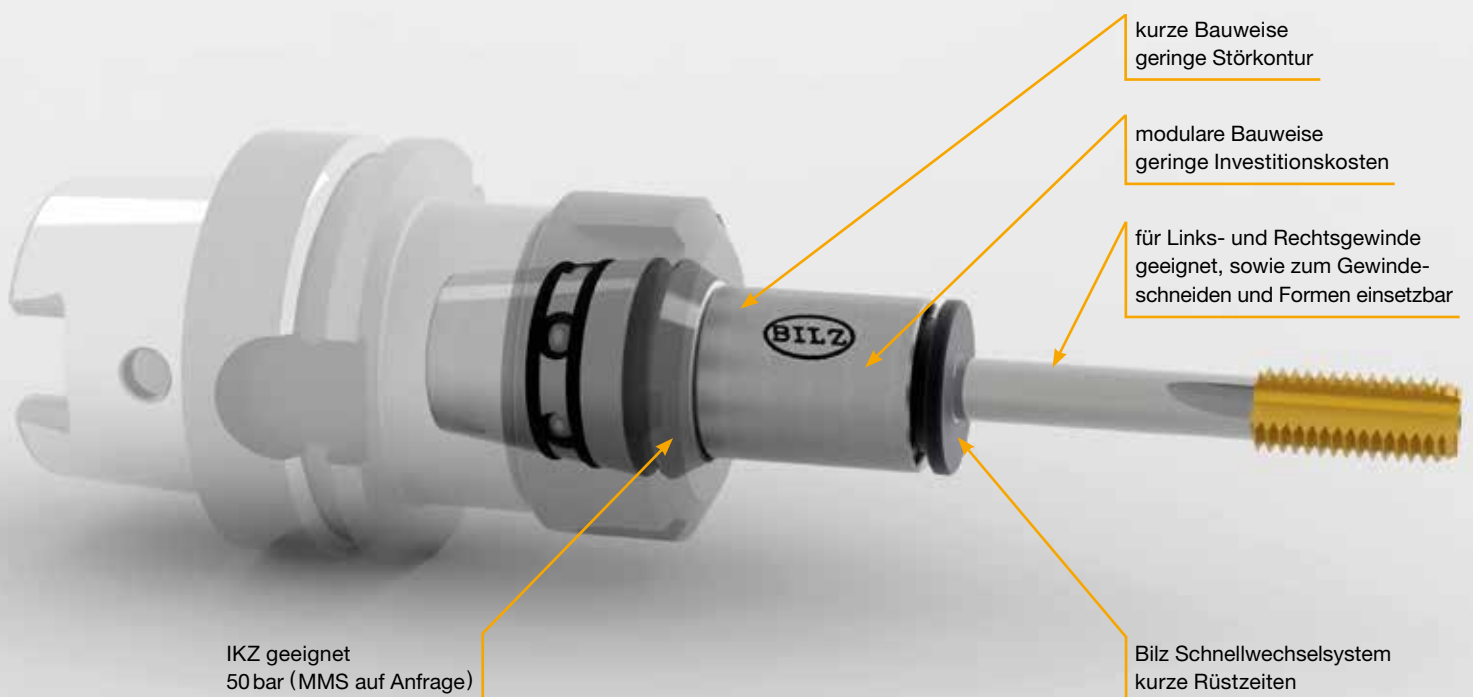



Synchroaufnahme (STL)			
Größe	Aufnahme Maschine	Bezeichnung	Ident Nr.
1	ER11	STL1-ER11	5099894
2	ER16	STL2-K1-ER16	5099865
2	ER16	STL2-K1-ER16	5099865
3	ER20	STL3-K1-ER20	5099856
4	ER25	STL4-K1-ER25	5099833
5	ER32	STL5-K1-ER32	5092917

Spannmutter
Ident Nr.
6919083
4600340
4600340 **
5056874 **
4600341 **
4600342 **

Synchrowerkzeugkopf (STH)			
Spannzange Werkzeug	Gewindegrößen	Bezeichnung	Ident Nr.
ER8***	M1 – M3,5	STH1-ER8M-22-N	5100306
ER11*	M3 – M8	STH2-ER11-30-K1	5111075
ER8***	M2 – M5	STH2-ER8M-21-N	5111080
ER11*	M3 – M8	STH3-ER11-28-K1	5111084
ER16	M4 – M12	STH4-ER16-42-K1	5111087
ER20	M6 – M14	STH5-ER20-46-K1	5111119

** auch für innenliegende Spannmuttern geeignet
 *** nicht IKZ

* bei ER11 gibt es keine Dichtscheibe, daher muss hier die passende Spannmutter für jedes Schaftmaß des Gewindebohrers separat bestellt werden.

STA Synchroersatz

- für Spannzangenaufnahmen nach ISO 15488 (DIN 6499)
- für synchronisiertes Gewindeschneiden und Gewindeformen
- Kühlmitteldruck: max. 50 bar
- Minimallängenausgleich: + 0,5 mm / - 0,2 mm

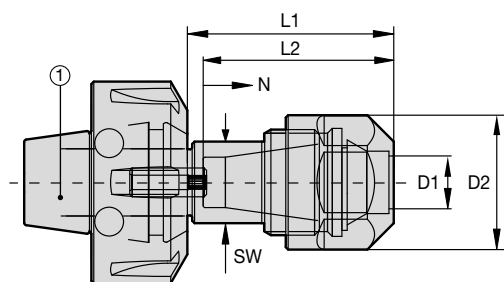

Synchroersatz komplett (STA)							
Größe	Anzugsmoment Spannmutter Mt max. Nm ①	D1	D2	L1	L2	N	SW
1	6	ER8	12	22	19	2	7
2	40	ER11	19	30	27	2	11
2	40	ER8	12	21,5	19	2	9
3	40	ER11	19	29	27	2	13
4	80	ER16	28	43	39	3	17
5	130	ER20	34	47	43,5	3	22

SW – Schlüsselweite zum Gegenhalten beim Anziehen der Spannmutter



Synchroaufnahme (STL)				Spann- mutter Ident Nr.	Synchrowerkzeugkopf (STH)			
Größe	Aufnahme Maschine	Bezeichnung	Ident Nr.		D1 x □ mm	Gewinde- größen	Bezeichnung	Ident Nr.
2	ER16	STL2-K1-ER16	5099865	4600340	3,5x2,7	M3 ; M5	STH2-0350X0270-24-K1	5100071
					4,5x3,4	M4 ; M6	STH2-0450X0340-24-K1	5100078
					5x4	M4 ; M5	STH2-0500X0400-24-K1	5100087
3	ER20	STL3-K1-ER20	5099856	5056874	6,0x4,9	M5 ; M6 ; M8	STH3-0600X0490-35-K1	5113800
					7,0x5,5	M7 ; M9 ; M10	STH3-0700X0550-35-K1	5100015
					7,0x5,5	M7 ; M9 ; M10	STH4-0700X0550-30-K1	5099927
4	ER25	STL4-K1-ER25	5099833	4600341	8,0x6,2	M8 ; M11	STH4-0800X0620-30-K1	5099948
					9,0x7,0	M9 ; M12	STH4-0900X0700-40-K1	5099939
					8,0x6,2	M8 ; M11	STH5-0800X0620-37-K1	5100155
5	ER32	STL5-K1-ER32	5092917	4600342	9,0x7,0	M9 ; M12	STH5-0900X0700-37-K1	5092928
					10,0x8,0	M10	STH5-1000X0800-37-K1	5100154
					11,0x9,0	M14	STH5-1100X0900-37-K1	5100157
					12,0x9,0	M12 ; M16	STH5-1200X0900-37-K1	5100156

STA Synchroeinsatz

- für Spannzangenaufnahmen nach ISO 15488 (DIN6499)
- für synchronisiertes Gewindeschneiden und Gewindeformen
- Kühlmitteldruck: max. 50 bar
- Minimallängenausgleich: + 0,5mm/- 0,2mm

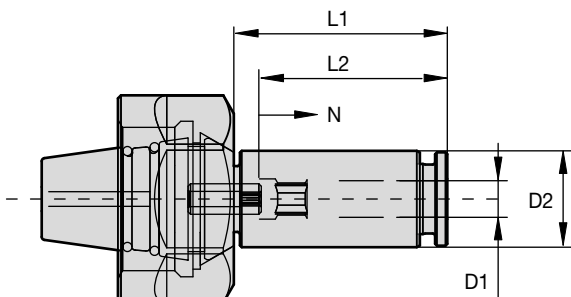

Synchroeinsatz komplett (STA)							
Größe	D1	D2	L1	L2	N	Anzugsmoment Spannmutter Mt max. Nm	Übertragbare Drehmomente Mt max. Nm
2	3,5	12,7	24	26	2	40	10
	4,5	12,7	24	26	2		
	5	12,7	24	27	2		
3	6	15,8	35	30,5	3	40	18
	7	15,8	35	30,5	3		
4	7	19	30	33	3	80	28
	8	19	30	34	3		
	9	19	40	35	3		
5	8	25	37	40	3	130	50
	9	25	37	41	3		
	10	25	37	42	3		
	11	25	37	43	3		
	12	25	37	43	3		

bilz

boehlerit

STA Synchro Tapping Adapter

Used with collet chucks ISO 15488 (DIN6499)





The new STA Synchro Tapping Adaptor was designed specifically for collet chucks and allows for synchronous thread cutting and forming to be used with all suitable machines.

Features:

- Suitable for coolant
- Minimal length compensation with compression and expansion
- Optimal damping
- Compact design
- Allows quick change of tool

ADVANTAGES:

- Removal of axial forces on the thread flanks
- Compensates for synchronization errors
- Low maintenance
- Can be used in narrow spindles

BENEFITS:

- Significant increase in service life and process reliability
- Better tapping quality
- Reduced risk of tool breakage
- Cost savings due to low tool requirement
- Low spindle maintenance

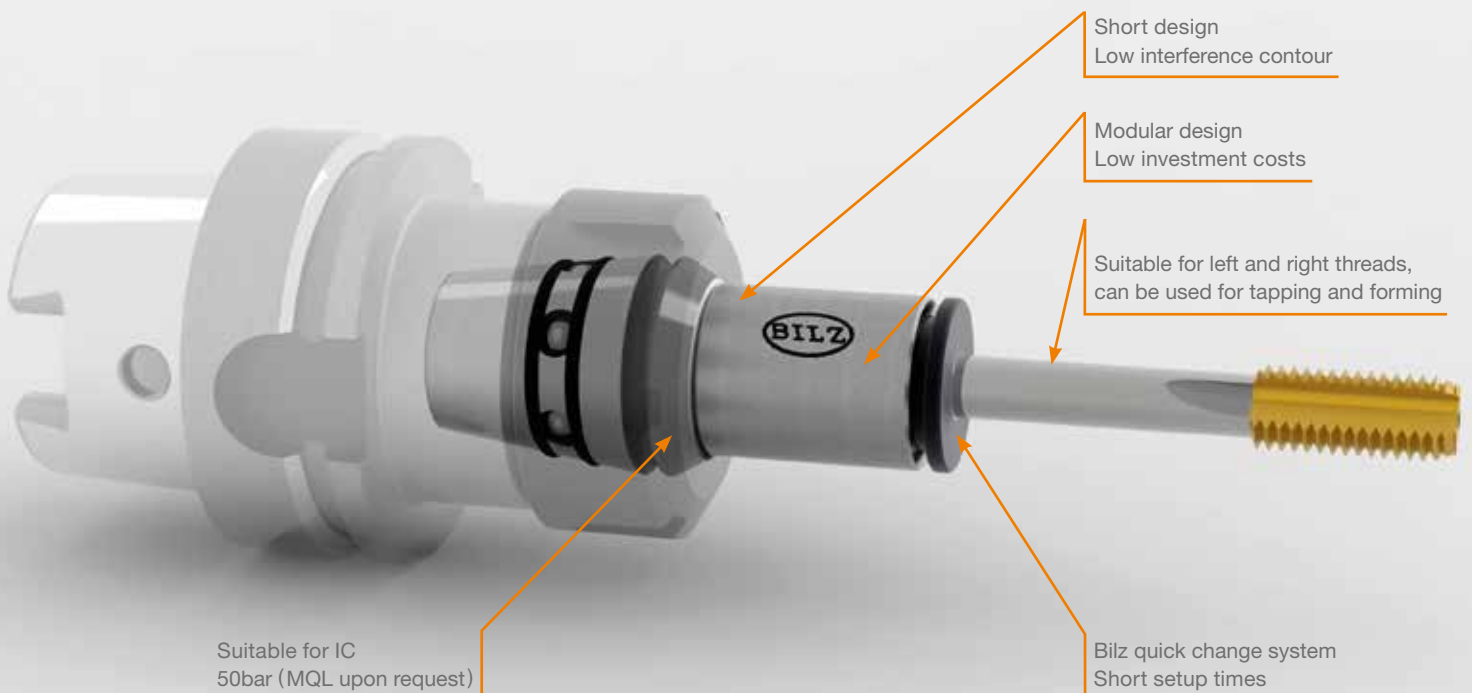



Synchro location (STL)			
Size	Location Machine	Designation	Ident No.
1	ER11	STL1-ER11	5099894
2	ER16	STL2-K1-ER16	5099865
2	ER16	STL2-K1-ER16	5099865
3	ER20	STL3-K1-ER20	5099856
4	ER25	STL4-K1-ER25	5099833
5	ER32	STL5-K1-ER32	5092917

Clamping nut
Ident No.
6919083
4600340
4600340 **
5056874 **
4600341 **
4600342 **

Synchro tool head (STH)			
Collet for tap	Thread sizes	Designation	Ident No.
ER8***	M1 – M3,5	STH1-ER8M-22-N	5100306
ER11*	M3 – M8	STH2-ER11-30-K1	5111075
ER8***	M2 – M5	STH2-ER8M-21-N	5111080
ER11*	M3 – M8	STH3-ER11-28-K1	5111084
ER16	M4 – M12	STH4-ER16-42-K1	5111087
ER20	M6 – M14	STH5-ER20-46-K1	5111119

** also suitable for internal clamping nuts
 *** no internal coolant

* there are no sealing discs for ER11, meaning that a suitable clamping nut for each tap shank dimension must be ordered separately.

STA Synchro Tapping Adaptor

- For collet chucks ISO 15488 (DIN 6499)
- For synchronized tapping and forming
- Coolant pressure: max. 50 bar
- Minimal length compensation: + 0,5 mm / - 0,2 mm

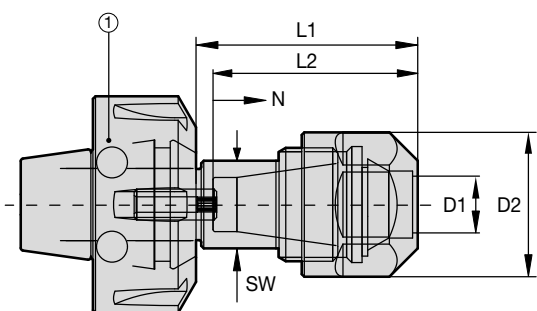

Synchro adaptor complete (STA)							
Size	Torque for clamping nut max. Nm ①	D1	D2	L1	L2	N	SW
1	6	ER8	12	22	19	2	7
2	40	ER11	19	30	27	2	11
2	40	ER8	12	21,5	19	2	9
3	40	ER11	19	29	27	2	13
4	80	ER16	28	43	39	3	17
5	130	ER20	34	47	43,5	3	22

SW – width across flats to hold when tightening the clamping nut.

STA Synchro Tapping Adaptor with Ball Bushing



Synchro location (STL)				Clamping nut Ident No.	Synchro tool head (STH)			
Size	Location Machine	Designation	Ident No.		D1 x □ mm	Thread sizes	Designation	Ident No.
2	ER16	STL2-K1-ER16	5099865	4600340	3,5x2,7	M3 ; M5	STH2-0350X0270-24-K1	5100071
					4,5x3,4	M4 ; M6	STH2-0450X0340-24-K1	5100078
					5x4	M4 ; M5	STH2-0500X0400-24-K1	5100087
3	ER20	STL3-K1-ER20	5099856	5056874	6,0x4,9	M5 ; M6 ; M8	STH3-0600X0490-35-K1	5113800
					7,0x5,5	M7 ; M9 ; M10	STH3-0700X0550-35-K1	5100015
					7,0x5,5	M7 ; M9 ; M10	STH4-0700X0550-30-K1	5099927
4	ER25	STL4-K1-ER25	5099833	4600341	8,0x6,2	M8 ; M11	STH4-0800X0620-30-K1	5099948
					9,0x7,0	M9 ; M12	STH4-0900X0700-40-K1	5099939
					8,0x6,2	M8 ; M11	STH5-0800X0620-37-K1	5100155
5	ER32	STL5-K1-ER32	5092917	4600342	9,0x7,0	M9 ; M12	STH5-0900X0700-37-K1	5092928
					10,0x8,0	M10	STH5-1000X0800-37-K1	5100154
					11,0x9,0	M14	STH5-1100X0900-37-K1	5100157
					12,0x9,0	M12 ; M16	STH5-1200X0900-37-K1	5100156



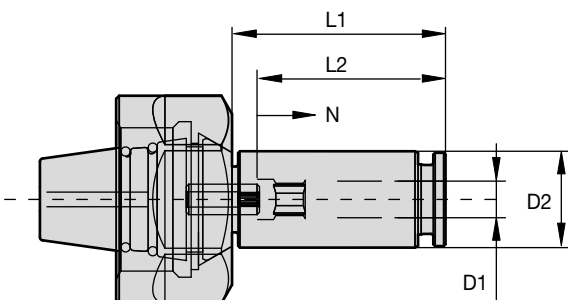

STA Synchro Tapping Adaptor

- For collet chucks ISO 15488 (DIN6499)
- For synchronized tapping and forming
- Coolant pressure: max. 50 bar
- Minimal length compensation: + 0,5mm/- 0,2mm

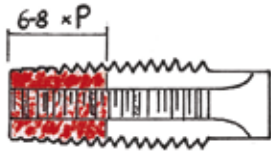

Synchro adaptor complete (STA)							
Size	D1	D2	L1	L2	N	Torque for clamping nut max. Nm	Transmissible torque max. Nm.
2	3,5	12,7	24	26	2	40	10
	4,5	12,7	24	26	2		
	5	12,7	24	27	2		
3	6	15,8	35	30,5	3	40	18
	7	15,8	35	30,5	3		
4	7	19	30	33	3	80	28
	8	19	30	34	3		
	9	19	40	35	3		
5	8	25	37	40	3	130	50
	9	25	37	41	3		
	10	25	37	42	3		
	11	25	37	43	3		

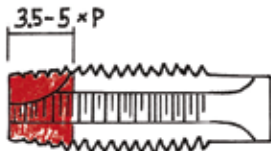
Technische Hinweise
Technical hints
Anhang
Attachment

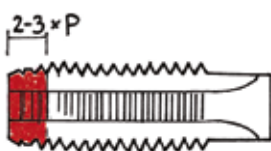
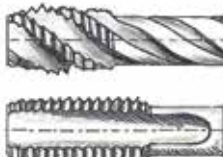
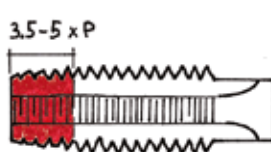
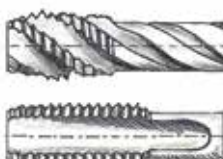
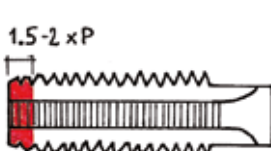
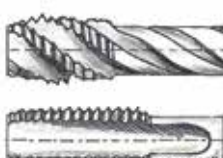
	Anschnittlänge Chamfer length	Nutenform Flute
Form A		
Form B		
Form C		
Form D		
Form E		

Eigenschaften von kurzen Anschnitten	short chamfer - characteristics
Kurze Anschnitte Für Grundlochgewinde Großer Spanquerschnitt Reduzierte Standzeit Geringes Drehmoment	Short chamfer for blind hole threads big chip diameter shorter tool life low torque
Eigenschaften von langen Anschnitten	long chamfer - characteristics
Lange Anschnitte Für Durchgangsgewinde dünner Spanquerschnitt erhöhte Standzeit hohes Drehmoment	Long chamfer for through hole threads small chip diameter longer tool life high torque

FORM A,C,E



**Gerade genutet
für Grund- und Durchgangsloch**

Späne werden in den Nuten aufgenommen, jedoch kaum transportiert. Tiefe Gewinde sollten daher nicht geschnitten werden.

**Tap with straight flutes
for through and blind hole**

Chips are picked up in the flute but hardly transported. Therefore, deep threads should not be cut with this type of tap.

FORM B



**Gerade genutet mit Schälanschnitt
für Durchgangslöcher**

Späne werden aufgrund des Schälanschnittes gerollt und fließen in Schneidrichtung ab.

**Tap with straight flutes and spiral point
for through hole**

Chips are rolled due to spiral point and flow off in the cutting direction.

FORM C,D



**15° linksgedallte Spiralnuten
für Durchgangslöcher**

Späne fließen aufgrund der linksgedallten Nuten in Schneidrichtung ab.

**Tap with 15° left hand spiral flutes
for through hole**

Chips flow off in the cutting direction due to the left hand spiral flutes.

FORM C,E 10-15°



**15° rechtsgedallte Spiralnuten
für Sacklöcher**

Späne fließen aufgrund der rechtsgedallten Nuten entgegen der Schneidrichtung ab.

**Tap with 15° right hand spiral flutes
for blind hole**

Chips flow off in the opposite direction of the cutting direction due to the right hand spiral flutes.

FORM C,E 35-50°



**35-50° rechtsgedallte Spiralnuten
für Sacklöcher**

Späne fließen auch in tiefen Gewinden, aufgrund der stark rechts gedallten Nuten, sicher entgegen der Schneidrichtung ab.

**Tap with 35-45° right hand twisted spiral flutes
for blind hole**

Chips surely flow off in deep threads against the cutting direction due to the strong right hand twisted spiral flutes.

Werkstoffe - Vergleichstabelle
Material Comparison Chart

ISO 513	Anwendung Application	Werkstoff- nummer Material number	DE DIN	I UNI	F AFNOR	USA ANSI/ASTM	Gruppe Group
P Stahl Steel	Magnet- weicheisen Mild / magnetic steel	1.1015	RFe60				P.1
		1.1014	RFe80				P.1
		1.1013	RFe100				P.1
	Baustahl unlegiert Construction steel	1.0037	St 37-2	Fe360B	E 24-2	1013	P.2
		1.0044	St 44-2	Fe430B	E 28-2	1021	P.2
		1.0050	St 50-2	Fe490	A 50-2	A 570 (50)	P.2
		1.0060	St 60-2	Fe590	A 60-2	A 572 (65)	P.2
		1.0570	St 52-3	Fe510B	E 36-3	1024	P.2
		1.0420	GS-38			A 27	P.3
	Stahlguss Steel castings	1.1118	GS-24Mn6				P.3
		1.1120	GS-20Mn5				P.3
		1.5419	GS-22Mo4				P.3
		1.5633	GS-24Ni8				P.3
		1.5681	GS-10Ni19			A757	P.3
		1.6309	GS-20MnMoNi5-5				P.3
		1.6582	GS-34CrNiMo6				P.3
		1.6748	GS-40NiCrMo6-5-6				P.3
		1.6750	GS-20NiCrMo3-7				P.3
		1.6760	GS-22NiMoCr5-6				P.3
		1.7357	GS-17CrMo5-5			A 217	P.3
		1.7379	GS-18CrMo9-10				P.3
		Einsatzstahl Cementation steel	1.0301	C10	C10	C10	1010
	1.0401		C15	C15	C18	1015	P.2
	1.7131		16MnCr5	16MnCr5	16 MC 5	5115	P.2
	1.7147		20MnCr5	20MnCr5	20 MC 5	5120	P.2
	1.7243		18CrMo4	18CrMo4			P.2
	1.5919		15CrNi6	16CrNi4	16 NC 6	4320	P.2
	1.6523		21NiCrMo2	20NiCrMo2	20 NCD 2	8620	P.2
	1.6587		17CrNiMo1106	18NiCrMo5-7	18 NCD6/18 NCD7	4320	P.2
	Nitrierstahl Nitriding steel	1.8515	31CrMo12	31CrMo12	30 CD 12	A/B	P.4
		1.8519	31CrMoV9	31CrMoV10			P.5
		1.8507	34CrAlMo5	34CrAlMo7	30 CAD 6.12	A355Cl.D	P.4
		1.8509	41CrAlMo7	41CrAlMo7	40 CAD 6.12	E7140	P.5
		1.0711	9S20	9S20		1212	P.1
	Automaten- stahl Free cutting steel	1.0715	9SMn28	9SMn28	S 250	1213	P.1
		1.0718	9SMnPb28	9SMnPb28	S 250 Pb	12 L 13	P.1
		1.0726	35S20	35S20	35 MF 4	1140	P.2
		1.0736	9SMn36	9SMn36	S 300	1215	P.1
		1.0737	9SMnPb36	9SMnPb36	S 300 Pb	12 L 14	P.1

ISO 513	Anwendung Application	Werkstoff- nummer Material numbe	DE DIN	I UNI	F AFNOR	USA ANSI/ASTM	Gruppe Group
P Stahl Steel	Vergütungs- stahl Heat treatable steel	1.0406	C25	C25	AF 50 C 30	1025	P3
		1.0528	C30	C30		1030	P3
		1.0501	C35	C35	AF 55 C 35	1035	P3
		1.0511	C40	C40	AF 60 C 40	1040	P3
		1.0503	C45	C45	AF 65 C 45	1045	P3
		1.0540	C50	C50		1050	P3
		1.0535	C55	C55	C54	1055	P3
		1.0601	C60	C60	C60	1060	P3
		1.7035	41Cr4	41Cr4	41Cr4	5140	P4
		1.8159	51CrV4	51CrV4	50 CV 4	6150	P4
		1.7218	25CrMo4	25CrMo4	25 CD 4	4130	P4
		1.7220	34CrMo4	34CrMo4	32 CD 4	4137	P4
		1.7225	42CrMo4	42CrMo4	42 CD 4	4140	P4
		1.7228	50CrMo4	50CrMo4	50CrMo4	4150	P4
		1.6580	30CrNiMo8	30CrNiMo8	30 NCD 8		P5
		1.6582	34CrNiMo6	34CrNiMo6	35 NCD 6	4337	P5
		1.6511	36CrNiMo4	36CrNiMo4	40 NCD 3	9840	P4
		1.6773	36NiCrMo16	36NiCrMo16			P5
	Kugellager- stahl Ball bearing steel	1.3505	100Cr6	100Cr6	100C6	52100	P4
		1.3536	100CrMo7-3	100CrMo7			P4
	Federstahl Spring steel	1.1231	Ck67	C67	XC 68	1070	P3
		1.1248	Ck75	C75		1074	P3
		1.1269	Ck85	C85	C90	1086	P3
		1.1274	Ck101	C100	C100	1095	P3
		1.5021		48Si7			P4
		1.5026	55Si7	55Si7	56SC7	9255	P4
		1.5027		60Si7	60Si7	9260	P4
		1.7108	60SiCr7	60SiCr8		9262	P4
		1.8159	51CrV4	51CrV4	50 CV 4	6150	P4
		1.7176	55Cr3	55Cr3	55 C 3	5155	P4
		1.7701	51CrMoV4	51CrMoV4			
	Stahl für die Oberflächen- härtung Case hardening steel	1.1183	Cf 35	C36	XC 68 H1TS		P3
		1.1193	Cf 45	C43	XC 42 H1TS		P3
		1.1213	Cf 53	C53	XC 48 H1TS	1050	P3
		1.7005	45Cr2	45Cr2			P4
		1.7043	38Cr4	38Cr4			P5
		1.7034	37Cr4	36CrMn4	38 4	5135	P5
		1.7223	41CrMo4	41CrMo4	42 CD 4 TS	4142	P5

Werkstoffe - Vergleichstabelle
Material Comparison Chart

ISO 513	Anwendung Application	Werkstoff- nummer Material number	DE DIN	I UNI	F AFNOR	USA ANSI/ ASTM	Gruppe Group
P Stahl Steel	Werkzeug- stahl für Warmarbeit Alloyed steel / tempered steel	1.2767	45NiCrMo16	40NiCrMoV16 KU	Y35NCD16		P.5
		1.2713	55NiCrMoV7	55NiCrMoV7 KU	55NiCrMoV7	L6	P.4
		1.2311		35CrMo8 KU			P.4
		1.2365	32CrMoV12-28	30CrMoV12-27 KU	32CDV12-28	H10	P.4
		1.2343	X38CrMoV5-1	X37CrMoV5-1 KU	Z38CDV5	H11	P.4
		1.2344	X40CrMoV5-1	X40CrMoV5-1-1 KU	Z40CDV5	H13	P.4
		1.2567	X30WCrV5-3	X30WCrV5-3 KU	Z32WCV5	H14	P.4
		1.2581	X30WCrV9-3	X30WCrV9-3 KU	Z30WCV9	H21	P.4
	Rostfreier Stahl ferritisch Ferritic stainless steel	1.4002	X6CrAl13	X6CrAl13	Z 8 CA 12	405	P.7
		1.4512	X2CrTi12	X6CrTi12	Z 3 CT 12	409	P.7
		1.4016	X6Cr17	X8Cr17	Z 8 C 17	430	P.7
		1.4104	X14CrMoS17	X10CrS17	Z 13 CF 17	430F	P.7
	Rostfreier Stahl mar- tensitisch Martensitic stainless steel	1.4006	X12Cr13	X12Cr13	Z 10 C 13	410	P.7
		1.4005	X12CrS13	X12CrS13	Z 11 CF 13	416	P.7
		1.4021	X20Cr13	X20Cr13	Z 20 C 13	420	P.7
		1.4028	X30Cr13	X30Cr13	Z 30 C 13	420	P.7
		1.4057	X17CrNi16-2	X16CrNi16	Z 15 CN 16-02	431	P.7
		1.4125	X105CrMo17		Z 100 CD 17	440C	P.7
		1.4542	X5CrNiCuNb16-4		Z 7 CNU 15-05	630	P.7
	M Rostfreier Stahl Stainless steel	austenitisch Austenitic stainless steel	1.4319	X3CrNiN17-8	X10CrNi1809		302
1.4305			X8CrNiS18-9	X10CrNiS1809	Z 8 CNF 18-09	303	M.1
1.4301			X5CrNi18-10	X5CrNi1810	Z 4 CN 19-10 FF	304	M.1
1.4306			X2CrNi19-11	X2CrNi1811	Z 1 CN 18-12	304L	M.1
1.4303			X4CrNi18-12	X8CrNi1812	Z 5 CN 18-11 FF	305	M.1
1.4828			X15CrNiSi20-12	X16CrNi2314	Z 9 CN 24-13	309	M.1
1.4841			X15CrNiSi25-20	X22CrNiSi2520	Z 15 CNS 25-20	310	M.1
1.4401			X5CrNiMo17-12-2	X5CrNiMo1712	Z 3 CND 17-11-01	316	M.1
1.4404			X2CrNiMo17-12-2	X2CrNiMo1712	Z 2 CND 17-12	316L	M.1
1.4541			X6CrNiTi18-10	X6CrNiTi1811	Z 6 CNT 18-10	321	M.1
1.4550		X6CrNiNb18-10	X6CrNiNb1811	Z 6 CNNb 18-10	347	M.1	
ferritisch + austenitisch Ferritic + austenitic (Duplex)		1.4462	X2CrNiMoN22-5-3	X2CrNiMoN22-5-3	Z 3 CND 22-05 Az	S31803	M.2
		1.4501	X2CrNiMoCuWN25-7-4	X2CrNiMoCuWN25-7-4		S32760	M.2
K Gusswerkstoffe Cast iron	Grauguss Grey cast iron	0.6010	GG10	G10	Ft10D	A48-20B	K.1
		0.6015	GG15	G15	Ft15D	A48-25B	K.1
		0.6020	GG20	G20	Ft20D	A48-30B	K.1
		0.6025	GG25	G25	Ft25D	A48-40B	K.1
		0.6030	GG30	G30	Ft30D	A48-45B	K.1
		0.6035	GG35	G35	Ft35D	A48-50B	K.1
		0.6040	GG40	G40	Ft40D	A48-60B	K.1

ISO 513	Anwendung Application	Werkstoff- nummer Material number	DE DIN	I UNI	F AFNOR	USA ANSI/ASTM	Gruppe Group	
K Gusswerkstoffe Cast iron	Kugelgrafit- Temperguss Nodular cast iron	0.7040	GGG40	GS400-12	FGS400-12	60-40-18	K.2	
		0.7050	GGG50	GS500-7	FGS500-7	65-45-12	K.2	
		0.7060	GGG60	GS600-3	FGS600-3	80-55-06	K.2	
		0.7070	GGG70	GS700-2	FGS700-2	100-70-03	K.2	
	Temperguss vergütet Tempered cast iron	0.8035	GTW35-04				K.2	
		0.8055	GTW55				K.2	
	ADI Austempered ductile iron		EN-GJS-800-8				K.3	
			EN-GJS-1000-5				K.3	
			EN-GJS-1200-2				K.3	
			EN-GJS-1400-1				K.3	
	N NE-Metalle Non-ferrous metals	Rein- aluminium Pure aluminium	3.0205	Al99	9001/1	1200 (A4)	1200	N.1
			3.0305	Al99.9				N.1
Aluminium- Knet- legierungen Aluminium wrought alloys		3.0505	AlMn0.5Mg0.5			3105		N.2
		3.0915	AlFeSi	8011	8011			N.2
		3.3315	AlMg1	9005/1		5005 (AlMg1)	5005	N.2
		3.3525	AlMg2Mn0.3			5251	5251	N.2
		3.3527	AlMg2Mn0.8			5049	5049	N.2
		3.3545	AlMg4Mn	9005/4		5086 (AG4MC)	5086	N.2
		3.3555	AlMg5					N.2
		3.0615	AlMgSiPb			6012		N.2
		3.1255	AlCuSiMn	9002/3		2014	2014	N.2
		3.1325	AlCuMg1	9002/2		2017 A (AU4G)	2017A	N.2
		3.1355	AlCuMg2	9002/4		2024 (AU4G1)	2024	N.2
		3.1645	AlCuMgPb	9002/8		2030 (AU4PB)	2030	N.2
		3.4335	AlZn4.5Mg1	9007/1		7020 (AZ5G)	7020	N.2
Aluminium Guss- legierungen Aluminium cast alloys		3.1371	G-AlCu4TiMg					N.2
		3.2134	G-AlSi5Cu1Mg					N.3
		3.3241	G-AlMg3Si					N.2
		3.3261	G-AlMg5Si					N.2
		3.3541	G-AlMg3					N.2
		3.2373	G-AlSi9Mg					N.3
		3.2381	G-AlSi10Mg					N.4
		3.2383	G-AlSi10Mg(Cu)					N.4
		3.2581	G-AlSi12					N.4
3.2583		G-AlSi12(Cu)					N.4	
Reinkupfer Pure copper		2.0060	E-Cu57				C1100	N.5
		2.0065	E-Cu58	5649	5649	CuA1	C11000	N.5

Werkstoffe - Vergleichstabelle
Material Comparison Chart

ISO 513	Anwendung Application	Werkstoff- nummer Material number	DE DIN	I UNI	F AFNOR	USA ANSI/ ASTM	Gruppe Group	
N NE-Metalle Non-ferrous metals	Kupfer Knet- legierungen Copper wrought alloys	2.1525	CuSi3Mn	CuSi3Mn1		C65500	N.6	
		2.0855	CuNi2Si	CuNi2Si		C64700	N.6	
		2.1247	CuBe2	Classe IV		C17200	N.6	
		2.1285	CuCo2Be	Classe III		C17510	N.6	
	Messing Copper- zinc alloys	2.0240	CuZn15				N.6	
		2.0250	CuZn20				N.6	
		2.0265	CuZn30			C26000	N.6	
		2.0280	CuZn33				N.6	
		2.0321	CuZn37			C27450	N.6	
		2.0360	CuZn40			C28000	N.7	
		2.0410	CuZn44Pb2	CuZn43Pb2Al		C38000	N.7	
		2.0550	CuZn40Al2	CuZn37Mn3Al2PbSi		C67410	N.7	
	Bronze Copper alloys	2.1016	CuSn4				N.6	
		2.1020	CuSn6				N.6	
		2.1030	CuSn8				N.6	
		2.1086	G-CuSn10Zn	7013	U-E12P7U-E8Z2	C90500	N.7	
		2.0978	CuAl11Ni6Fe6	CuAl11Fe6Ni6			N.8	
		2.0940	CuAl10Fe	5274		C95400	N.8	
		2.0882	CuNi30Mn1Fe				N.8	
	Magnesium Magnesium alloys	3.5312	MgAl3Zn				N.9	
		3.5632	MgAl6Zn3				N.9	
		3.5912	MgAl9Zn1				N.9	
		3.5161	MgZn6Zr				N.10	
	S Superlegierungen Titanlegierungen Titanium alloys	Reintitan Pure titanium	3.7024	Ti99.5				S.1
			3.7034	Ti99.7				S.1
		Titan- legierungen Titanium alloys	3.7165	TiAl6V4			T-A6V	S.2
			3.7174	TiAl6V4Sn2				S.2
		Reinnickel Pure nickel	1.3911	RNi24				S.3
1.3926			RNi12				S.3	
Nickel- legierungen Nickel alloys		2.4858	NiCr21Mo (Incoloy 825)				S.4	
		2.4668	NiCr19Fe19NbMo (Inconel 718)			INCONEL 718	S.4	
		2.4630	Ni-Cr20Ti (Nimonic 75)			NIMONIC 75	S.4	
		2.4665	NiCr22Fe18Mo (Hastelloy X)				S.4	

ISO 513	Anwendung Application	Werkstoff- nummer Material number	DE DIN	I UNI	F AFNOR	USA ANSI/ASTM	Gruppe Group	
H Gehärtete Werkstoffe Hardened materials	Kugellager- stahl Ball bearing steel	1.3505	100Cr6	100Cr6	100C6	52100	H.2	
		1.3536	100CrMo6	100CrMo7	100CD7	3	H.2	
	Werkzeugstahl für Warmarbeit High strenght steel	1.2767	45NiCrMo16	40NiCrMoV16 KU	Y35NCD16		H.1	
		1.2713	55NiCrMoV7	55NiCrMoV7 KU	55NiCrMoV7	L6	H.1	
		1.2311		35CrMo8 KU			H.1	
		1.2365	32CrMoV12-28	30CrMoV12-27 KU	32CDV12-28	H10	H.1	
		1.2343	X38CrMoV5-1	X37CrMoV5-1 KU	Z38CDV5	H11	H.1	
		1.2344	X40CrMoV5-1	X40CrMoV5-1-1 KU	Z40CDV5	H13	H.1	
		1.2567	X30WCrV5-3	X30WCrV5-3 KU	Z32WCV5	H14	H.1	
		1.2581	X30WCrV9-3	X30WCrV9-3 KU	Z30WCV9	H21	H.1	
	Gehärtete Stähle Hardened steel Stahlguss Hard castings	Weldox 1100					Weldox 1100	H.1
		Hardox 500					Hardox 500	H.2
		Hardox 550					Hardox 550	H.2
		1.2713	55NiCrMoV6			55 NCDV 7	L 6	H.2
		Armorox 600T					Armorox 600T	H.2
		1.2542	45WCrV7	45 WCrV 8 KU			S 1	H.2
		1.2379	X155CrVMo12-1	X 155 CrVMo 12 1KU			D 2	H.2
1.2436		X210CrW12	X 215 CrVMo 12 1KU				H.2	

Härtevergleichstabelle
Conversion Table Hardness vs. Tensile Strength

Zugfestigkeit Tensile Strength Rm N/mm ²	Vickers HV	Brinell HB	Rockwell HRC
545	170	162	
575	180	171	
610	190	181	
640	200	190	
675	210	199	
705	220	209	
740	230	219	
770	240	228	20,3
800	250	238	22,2
835	260	247	24,0
865	270	257	25,6
900	280	266	27,1
930	290	276	28,5
965	300	285	29,8
995	310	295	31,0
1030	320	304	32,2
1060	330	314	33,3
1095	340	323	34,4
1125	350	333	35,5
1155	360	342	36,6
1190	370	352	37,7
1220	380	361	38,8
1255	390	371	39,8
1290	400	380	40,8
1320	410	390	41,8
1350	420	399	42,7
1385	430	409	43,6
1420	440	418	44,5
1455	450	428	45,3
1485	460	437	46,1
1520	470	447	46,9
1555	480	456	47,7
1595	490	466	48,4
1630	500	475	49,1
1665	510	485	49,8
1700	520	494	50,5
1740	530	504	51,1
1775	540	513	51,7
1810	550	523	52,3
1845	560	532	53,0
1880	570	542	53,6
1920	580	551	54,1

Härtevergleichstabelle
Conversion Table Hardness vs. Tensile Strength



Zugfestigkeit Tensile Strength Rm N/mm ²	Vickers HV	Brinell HB	Rockwell HRC
1955	590	561	54,7
1995	600	570	55,2
2030	610	580	55,7
2070	620	589	56,3
2105	630	599	56,8
2145	640	608	57,3
2180	650	618	57,8
	660		58,3
	670		58,8
	680		59,2
	690		59,7
	700		60,1
	720		61,0
	740		61,8
	760		62,5
	780		63,3
	800		64,0
	820		64,7
	840		65,3
	860		65,9
	880		66,4
	900		67,0
	920		67,5
	940		68,0
	720		61,0
	740		61,8
	760		62,5
	780		63,3
	800		64,0
	820		64,7
	840		65,3
	860		65,9
	880		66,4
	900		67,0
	920		67,5
	940		68,0
	900		67,0
	920		67,5
	940		68,0
	900		67,0
	920		67,5
	940		68,0

ISO 513	Werkstoff	Gruppe	Bezeichnung	Festigkeit N/mm ²
P	Stahl	P.1	Magnetweicheisen	200 - 400
		P.2	Baustahl, Einsatzstahl	350 - 700
		P.3	Kohlenstoffstahl / unlegierter Gussstahl	350 - 850
		P.4	legierter Stahl / Vergütungsstahl	500 - 850
		P.5	legierter Stahl / Vergütungsstahl	850 - 1200
		P.6	legierter Stahl mit erhöhter Festigkeit	1200 - 1600
		P.7	rostfreier Stahl ferritisch, martensitisch	< 1000
M	Rost- und säurebeständiger Stahl	M.1	rostfreier Stahl austenitisch	< 850
		M.2	rostfreier Stahl ferritisch + martensitisch (Duplex)	< 1000
K	Gusswerkstoffe	K.1	Grauguss	< 1000
		K.2	Kugelgraphitguss, Temperguss	< 1000
		K.3	ADI (austenitisch-ferritisches Gusseisen mit Kugelgraphit)	< 1400
N	Aluminium / Legierungen	N.1	Reinaluminium unlegiert	< 300
		N.2	Aluminium-Legierungen Si < 0,5% (langspanend)	< 500
		N.3	Aluminium-Legierungen Si < 10% (mittlere Spanlänge)	< 500
		N.4	Aluminium-Legierungen Si > 10% (kurzspanend)	< 600
	Kupfer / Legierungen Messing Bronze	N.5	Reinkupfer / Elektrolytkupfer	250 - 350
		N.6	Kupferlegierungen / Messing langspanend	< 700
		N.7	Kupferlegierungen / Messing kurzspanend	< 700
		N.8	Kupferlegierungen mit erhöhter Festigkeit	700 - 1500
	Magnesium / Legierungen	N.9	Reinmagnesium / Legierungen	120 - 300
		N.10	Magnesiumlegierungen mit erhöhter Festigkeit	240 - 400
S	Titan / Legierungen	S.1	Reintitan	400 - 600
		S.2	Titanlegierungen	600 - 1000
	Nickel / Legierungen	S.3	Reinnickel	400 - 600
		S.4	Nickellegierungen	600 - 1000
	Zink	S.5	Zink und Zinklegierungen	170 - 400
H	gehärtete Werkstoffe	H.1	gehärteter Stahl (44 - 55 HRC)	-
		H.2	gehärteter Stahl (56 - 62 HRC)	

ISO 513	Material	Group	Application	Res.N/mm2
P	Steel	P.1	Mild / magnetic steel	200 - 400
		P.2	Construction steel, case hardening steel	350 - 700
		P.3	Carbon steel	350 - 850
		P.4	Alloyed steel / tempered steel	500 - 850
		P.5	Alloyed steel / tempered steel	850 - 1200
		P.6	Alloyed steel / high strength steel	1200 - 1600
		P.7	Ferritic stainless steel, martensitic stainless steel, precipitation hardening	< 1000
M	Stainless steel	M.1	Austenitic stainless steel	< 850
		M.2	Ferritic+austenitic (Duplex)	< 1000
K	Cast iron	K.1	Grey cast iron	< 1000
		K.2	Nodular cast iron, malleable cast iron, tempered cast iron	< 1000
		K.3	Austempered ductile iron (ADI)	< 1400
N	Aluminium Aluminium alloys	N.1	Pure aluminium	< 300
		N.2	Aluminium wrought and die cast alloys with Si < 0,5% (long chipping)	< 500
		N.3	Aluminium wrought and die cast alloys with Si < 10% (medium chipping)	< 500
		N.4	Aluminium die cast alloys with Si > 10% (short chipping)	< 600
	Copper Copper alloys Brass Bronze	N.5	Pure copper	250 - 350
		N.6	Copper alloys (long chipping), soft brass	< 700
		N.7	Copper alloys (short chipping), hard brass	< 700
		N.8	High strength bronze	700 - 1500
	Magnesium Magnesium alloys	N.9	Pure magnesium, magnesium alloys	120 - 300
		N.10	High strength magnesium alloy	240 - 400
S	Titanium Titanium alloys	S.1	Pure titanium	400 - 600
		S.2	Titanium alloys	600 - 1000
	Nickel Nickel alloys	S.3	Pure nickel	400 - 600
		S.4	Nickel alloys	600 - 1000
	Zinc	S.5	Zinc, Zinc alloys	170 - 400
H	Hardened materials	H.1	Alloyed steel, hardness HRC 44-55	-
		H.2	Alloyed steel, hardness HRC 56-63	

BOEHLERIT GmbH & Co. KG

Werk VI-Strasse 100
8605 Kapfenberg
Österreich/Austria
Telefon +43 3862 300 - 0
Telefax +43 3862 300 - 793
info@boehlerit.com
www.boehlerit.com

Argentinien/Argentina

SIN PAR S.A.
Conesa 10
B1878KSB Quilmes -
Buenos Aires
Telefon +54 11 4257 4396
Telefax +54 11 4224 5687
ventas@sinpar.com.ar
www.sinpar.net
www.boehlerit.com

Brasilien/Brazil

Boehlerit Brasil Ferramentas Ltda.
Rua Capricórnio 72
Alpha Conde Comercial I
06473-005 - Barueri -
São Paulo
Telefon +55 11 554 60 755
Telefax +55 11 554 60 476
info@boehlerit.com.br
www.boehlerit.com

China/China

Boehlerit China Co. Ltd.
Swiss Center Shanghai
Room A107, Building 3
No. 526, 3rd East Fute Road
Shanghai Pilot Free Trade Zone
200131 P.R. China
Telefon +86 137 358 950 58
info@boehlerit.com.cn

HORN (Shanghai) Trading Co. Ltd.
Room 905, No 518 Anyuan Road
Putuo District
Shanghai 20060
Telefon +86 21 528 33 505, 528 33 205
Telefax +86 21 528 32 562
info@phorn.cn
www.phorn.cn

Deutschland/Germany

Boehlerit GmbH & Co. KG
Werk VI-Strasse 100
8605 Kapfenberg
Österreich/Austria
Telefon +43 3862 300-0
Telefax +43 3862 300-793
info@boehlerit.com
www.boehlerit.com

Paul Horn GmbH
Unter dem Holz 33-35,
72072 Tübingen
Deutschland/Germany
Tel.: +49 7071-7004-0
Fax: +49 7071-72893
info@phorn.de
www.phorn.de

Großbritannien/

United Kingdom
LMT UK Ltd
4202 Waterside Centre,
Solihull Parkway
B37 7YN Birmingham
Telefon +44 16 76 523440
Telefax +44 16 76 525379
lmt.uk@lmt-tools.com
www.lmt-uk.co.uk
www.boehlerit.com

HORN CUTTING TOOLS Ltd.

32 New Street, Ringwood,
Hampshire BH24 3AD
Telefon +44 1425 481 800
Telefax +44 1425 481 888
info@phorn.co.uk
www.phorn.co.uk

Finnland/Finland

Oy Maanterä AB
Keinumäenkuja 2, P.O. Box 70
01510 Vantaa
Telefon +358 29 006 130
Telefax +358 29 006 1130
maanterä@maanterä.fi
www.maanterä.fi
www.boehlerit.com

Frankreich/France

Horn SAS
665 Av Blaise Pascal
77127 Lieusaint
Telefon +33 164 88 5958
Telefax +33 164 88 6049
infos@horn.fr
www.hornfrance.fr

Horn SAS

564 rue Claude Ballaloud
ZAE Bord d'Arve
74950 Scionzier
Telefon +33 4050 183148
Telefax +33 4050 182171
contact@horn.fr

Indien/India

LMT Fette (India) Pvt Ltd
29 (Old No. 14) II Main Road
Gandhinagar, Adyar
Chennai 600 020, India
Telefon +91 44 244 05 136
Telefax +91 44 244 05 205
lmt.in@lmt-tools.com
www.lmt-tools.com
www.boehlerit.com

Italien/Italy

Boehlerit Italy S.r.l.
Via Papa Giovanni XXIII, Nr. 45
20090 Rodano (MI)
Telefon +39 02 269 49 71
Telefax +39 02 218 72 456
info@boehlerit.it
www.boehlerit.com

Iran/Iran

Taban Abzar Pars Co
(TAPCO)
No 19, Rezaei Alley
Derakhi St, Sepehr St,
Farahzadi Blv Shahrak Gharb
Tehran, Iran
info@tabanabzar.com
Telefon +98-21-88583487-9
Telefax +98-21-88086744

Kroatien/Bosnien & Herzegowina

Croatia/Bosnia & Herzegovina
Bulgarien/Bulgaria
Montenegro/Montenegro
Rumänien/Romania
Serbien/Serbia
HORN Magyarorszáგ Kft.
Gesztenyefa u. 4
9027 Győr
Telefon +36 96 55 05 31
Telefax +36 96 55 05 32
technik@phorn.hu
www.horn.hu

Mexiko/Mexico

Boehlerit S.A. de C.V.
Av. Acueducto No. 15
Parque Industrial Bernardo Quintana
El Marqués, Querétaro
México. C.P. 76246
Telefon +52 442 221 5706
Telefax +52 442 221 5555
info@boehlerit.com.mx
www.boehlerit.com

Niederlande/Netherlands

Hagro Precisie b.v.
Industriepark 18
NL-5374 CM Schaijk
Telefon +31 486 462 424
Telefax +31 486 461 650
hagro@hagro.nl
www.hagro.nl
www.boehlerit.com

Polen/Poland

Boehlerit Polska sp.z.o.o.
Zlotniki, ul. Kobaltowa 6
62-002 Suchy Las
Telefon +48 61 659 38 00
Telefax +48 61 623 20 14
info@boehlerit.pl
www.boehlerit.com

Rumänien/Romania

SC Profil Construct Expert SRL
Matei Corvin nr. 402 Hala 1
410313 Oradea, ROMANIA
Telefon +40 359 176 400
Telefax +40 745 411 695
viorel@pcetools.ro
www.pcetools.ro
www.boehlerit.com

Russland/Russia

000 "Metin Group"
Skladochnaya, 6
127018, Moscow
Telefon +7 495 921 1342
Telefax +7 495 921 1342
www.boehlerit.com

HORN RUS LLC

5 Bryanskaya street
121059, Moscow
Telefon +7 495 968 21 68
Telefax +7 495 960 21 68
www.hornrus.com
www.boehlerit.com

Schweden/Sweden

HORN Sverige & Danmark
Powered by JR TOOL ApS
Box 1902
SE-701 19 Örebro
Telefon + 46 19 / 277 76 06
Telefax +46 19 / 277 76 08
info@phorn.se
www.phorn.se
www.boehlerit.com

Schweiz/Switzerland

Vargus Werkzeugtechnik Snel AG
Knonauerstraße 56
6330 Cham 1
Telefon +41 41 784 21 21
Telefax +41 41 784 21 39
info@vargus.ch
www.vargus.ch
www.boehlerit.com

Singapur/Singapore

Boehlerit Asia Pte Ltd
1 Clementi Loop 04-01
Clementi West District Park
Singapore 12 98 08
Telefon +65 64 62 1608
Telefax +65 64 62 4215
info@boehleritasia.com
www.boehlerit.com

Slowakei/Slovakia

Kancelár Boehlerit
Santraziny 753
760 01 Zlín
Telefon +420 577 214 989
Telefax +420 577 219 061
boehlerit@boehlerit.cz
www.boehlerit.com

Slowenien/Slovenia

KAC trade d.o.o.
Ložnica pri Žalcu 46
3310 Žalec
Telefon: +386 3 710 40 80
Telefax: +386 3 710 40 81
info@kactrade.si
www.kactrade.com
www.boehlerit.com

Spanien/Spain

Boehlerit Spain S.L.
C/. Narcis Monturiol 11-15
08339 Vilassar de Dalt Barcelona
Telefon +34 93 750 7907
Telefax +34 93 750 7925
info@boehlerit.es
www.boehlerit.com

Südkorea/South Korea

LMT Korea Co., Ltd
Room # 1520,
Anyang Trade Center
Bisan-Dong, Dongan-Gu
Anyang-Si, Gyeonggi-Do,
431-817, South Korea
Telefon +82 31 384 8600
Telefax +82 31 384 2121
lmt.kr@lmt-tools.com
www.lmt-tools.com
www.boehlerit.com

Tschechien

Czech Republic
Kancelár Boehlerit
Santraziny 753
760 01 Zlín
Telefon +420 577 214 989
Telefax +420 577 219 061
boehlerit@boehlerit.cz
www.boehlerit.com

Türkei/Turkey

Boehlerit
Sert Metal ve Takim Sanayi
ve Ticaret A Ş
Gosb 1600. Sok.No: 1602
41480 Gebze - Kocaeli
Telefon +90 262 677 1737
Telefax +90 262 677 1746
bohler@bohler.com.tr
www.bohler.com.tr
www.boehlerit.com

Ungarn/Hungary

Boehlerit Hungária Kft.
PO Box: 2036 Érdliget Pf. 32
2030-Érd, Kis-Duna u.6.
Telefon +36 23 521 910
Telefax +36 23 521 919
info@boehlerit.hu
www.boehlerit.com

USA

Kanada/Canada
Boehlerit USA
1140 No.Main St.
Lombard IL 60148
Telefon +1 847 734 9390
Telefax +1 847 734 9391
www.boehlerit.com

HORN USA, Inc.

320 Premier Court, Suite 205
Franklin, TN37067
Telefon +1 888 818-HORN
Telefax +1 615 771-4101
sales@hornusa.com
www.hornusa.com